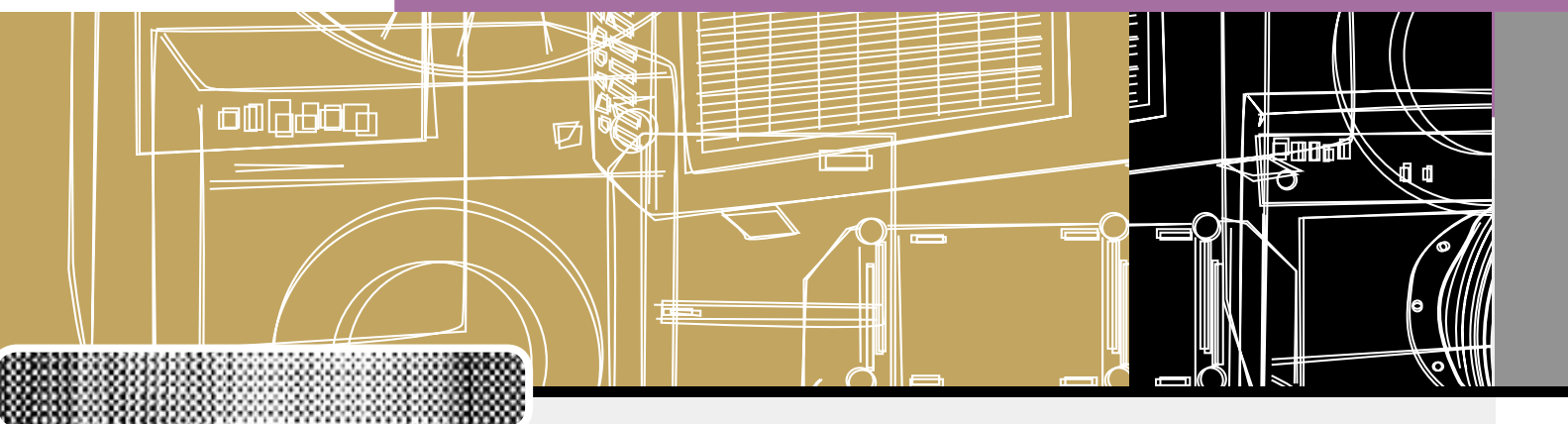


*NATIONAL APPLIANCE AND EQUIPMENT
ENERGY EFFICIENCY PROGRAM*

*APPLIANCE STANDBY POWER CONSUMPTION
STORE SURVEY 2003*



August 2003

AN INITIATIVE OF THE MINISTERIAL COUNCIL
ON ENERGY FORMING PART OF THE
NATIONAL GREENHOUSE STRATEGY

MINISTERIAL COUNCIL ON ENERGY As at 23 May 2003

COMMONWEALTH (CHAIR)

The Hon Ian Macfarlane MP
Minister for Industry, Tourism and Resources

AUSTRALIAN CAPITAL TERRITORY

Mr Ted Quinlan MLA
Deputy Chief Minister
Treasurer
Minister for Economic Development, Business and Tourism
Minister for Sport, Racing and Gaming

NEW SOUTH WALES

The Hon Frank Sartor MP
Minister for Energy and Utilities
Minister for Science and Medical Research
Minister Assisting the Minister for Health (Cancer)
Minister Assisting the Minister for the Arts

TASMANIA

The Hon Paul Lennon MHA
Deputy Premier
Minister for Economic Development, Energy and Resources

NORTHERN TERRITORY

The Hon Paul Henderson MLA
Minister for Business, Industry and Resource Development

QUEENSLAND

The Hon Paul Lucas MP
Minister for Innovation and Information Economy
Minister with responsibility for Energy

SOUTH AUSTRALIA

The Hon Patrick Conlon MP
Minister for Energy

VICTORIA

The Hon Theo Theophanous MLC
Minister for Energy Industries
Minister for Resources

WESTERN AUSTRALIA

The Hon E S (Eric) Ripper MLA
Deputy Premier
Treasurer
Minister for Energy

OBSERVERS

NEW ZEALAND

The Hon Pete Hodgson
Minister of Energy

PAPUA NEW GUINEA

Hon Sir Moi Awei KBE MP
Minister for Petroleum and Energy

© Commonwealth of Australia 2003

This work may be reproduced in whole or part for study or training purposes subject to an inclusion of an acknowledgment of the source and no commercial use or sale. Reproduction for the purposes other than those named above requires the permission of the Australian Greenhouse Office. Requests and inquiries concerning reproduction rights should be addressed to:



AUSTRALIAN
Greenhouse
Office

The Communication Director
Australian Greenhouse Office
GPO Box 621
CANBERRA ACT 2601

For additional copies of this document, please contact the Australian Greenhouse Office Infoline 1300 130 606.

This publication is also available on the internet on the following address:
www.energyrating.gov.au

August 2003

Contents

Introduction	7
Background	7
Definition of “Standby”	7
Aims & objectives	8
Research Methods	9
Equipment and Preparation	9
Problems encountered during data collection	11
Acknowledgements	11
Results	12
Overview	12
Product Summaries	13
Major Appliances	13
Small Appliances	19
Computers and Peripherals	24
Home Entertainment Equipment	31
Price and Standby Power Consumption	54
References	61



Index of Tables

Table 1 – A summary of modes tested by appliance type for this survey	10
Table 2 – A summary of air conditioner results - 2003	13
Table 3 – Trends in standby for air conditioners	13
Table 4 – A summary of clothes dryer results - 2003	14
Table 5 – Trends in standby for clothes dryers	15
Table 6 – A summary of clothes washer/dryer results - 2003	16
Table 7 – Trends in standby for clothes washer/dryers	16
Table 8 – A summary of dishwasher results - 2003	16
Table 9 – Trends in standby for dishwashers	16
Table 10 – A summary of washing machine results - 2003	17
Table 11 – Trends in standby for washing machines	18
Table 12 – A summary of breadmaker results - 2003	19
Table 13 – Trends in standby for breadmakers	19
Table 14 – A summary of hand-held vacuum cleaner results - 2003	20
Table 15 – Trends in standby for hand held vacuum cleaner	20
Table 16 – A summary of microwave results - 2003	22
Table 17 – Trends in standby for microwaves	22
Table 18 – A summary of espresso machine results - 2003	24
Table 19 – A summary of Hard Drive/CPU Box results - 2003	24
Table 20 – Trends in standby for computers box	25
Table 21 – A summary of portable computer results - 2003	26
Table 22 – A summary of computer monitor results - 2003	26
Table 23 – Trends in standby for computers monitors	26
Table 24 – A summary of inkjet printers results - 2003	28
Table 25 – Trends in standby for inkjet printers	28
Table 26 – A summary of laser printer results - 2003	30

Table 27 – Trends in standby for laser printers	30
Table 28 – A summary of television results - 2003	31
Table 29 – Trends in standby for televisions – standard	32
Table 30 – Trends in standby for televisions – LCD	34
Table 31 – Trends in standby for televisions – Projection	34
Table 34 – Trends in standby for televisions – Plasma	36
Table 33 – A summary of plasma TV results - 2003	36
Table 35 – Trends in standby for TV/VCR	38
Table 36 – A summary of VCR results - 2003	39
Table 37 – Trends in standby for VCR	39
Table 38 – A summary of DVD/VCR combination unit results	40
Table 39– Trends in standby for DVD & VCR Player	40
Table 41– Trends in standby for DVD - Players	41
Table 40 – A summary of DVD player results - 2003	42
Table 42 – A summary of integrated stereo results - 2003	44
Table 43 – Trends in standby for integrated stereo	44
Table 44 – A summary of portable stereo results - 2003	47
Table 45 – Trends in standby for portable stereo	47
Table 46 – A summary of AV Receiver results - 2003	50
Table 47 – Trends in standby for home theatre – AV receiver	50
Table 48 – A summary of AV Receiver/DVD player results - 2003	52
Table 49 – A summary of subwoofer results - 2003	53
Table 50 – A summary of price vs standby power consumption analysis	54



Index of Figures

Figure 1 – Power measurements for air conditioners: off mode	14
Figure 2 – Power measurements for clothes dryers: off mode	15
Figure 3 – Power measurements for dishwashers: off mode	17
Figure 4 – Power measurements for washing machines: off mode	18
Figure 5 – Power measurements for breadmakers: off mode	19
Figure 6 – Power measurements for hand-held vacuum cleaners: active standby mode	21
Figure 7 – Power measurements for hand-held vacuum cleaners: passive standby mode	21
Figure 8 – Power measurements for microwaves: passive standby mode	23
Figure 9 – Power measurements for computers: off mode	25
Figure 10 – Power measurements for monitors: off mode	27
Figure 11 – Power measurements for inkjet printers: passive standby mode	29
Figure 12 – Power measurements for inkjet printers: off mode	29
Figure 13 – Power measurements for televisions: in-use mode	32
Figure 14 – Power measurements for televisions: passive standby mode	33
Figure 15 – Power measurements for televisions: off mode	33
Figure 16 – Power measurements for projection televisions: passive standby mode	35
Table 32 – A summary of projection TV results - 2003	35
Figure 17 – Power measurements for plasma televisions: passive standby mode	37
Figure 18 – Power measurements for plasma televisions: off mode	37
Figure 19 – Power measurements for VCR: active standby mode	39
Figure 20 – Power measurements for VCR: passive standby mode	40
Figure 21 – Power measurements for DVD players: active standby mode	42
Figure 22 – Power measurements for DVD players: passive standby mode	43
Figure 23 – Power measurements for DVD players: off mode	43
Figure 24 – Power measurements for integrated stereos: active standby mode	45
Figure 25 – Power measurements for integrated stereos: passive standby mode	46
Figure 26 – Power measurements for portable stereos: active standby mode	48
Figure 27 – Power measurements for portable stereos: passive standby mode	48
Figure 28 – Power measurements for AV receivers: passive standby mode	50
Figure 29 – Power measurements for AV receivers: off mode	51
Figure 30 – Power measurements for AV receivers with DVD players: passive standby mode	52
Figure 31 – Price vs passive standby performance: Standard TVs (screen size 34cm to 51cm)	55
Figure 32 – Price vs passive standby performance: Standard TVs (screen size 52cm to 82cm))	55
Figure 33 – Price vs passive standby performance: VCRs	56
Figure 34 – Price vs active standby performance: VCRs	56
Figure 35 – Price vs passive standby performance: DVD players	57
Figure 36 – Price vs active standby performance: DVD players	57
Figure 38 – Price vs passive standby performance: Integrated Stereos	58
Figure 37 – Price vs passive standby performance: AV Receivers	58
Figure 39 – Price vs passive standby performance: Portable Stereos	59
Figure 40 – Price vs passive standby performance: Microwaves	59
Figure 41 – Price vs off mode measurements: Washing Machines	60

INTRODUCTION

Background

In recent years, the increase in energy consumption from appliances not being used for their primary purpose (or in “standby” mode) has become a major concern in terms of the potential contribution to greenhouse gas emissions.

In order to more accurately quantify the contribution “standby” power makes to greenhouse gas emissions in Australia, the Australian Greenhouse Office (AGO) and the National Appliance & Equipment Energy Efficiency Committee (NAEEEC) commissioned the report, *Quantification of Residential Standby Power Consumption in Australia* (EES and EnergyConsult, 2001). This study, conducted in late 2000, provides results of an intrusive survey where measurements on 2,500 appliances were undertaken in 64 houses in Melbourne, Sydney and Brisbane. The report also includes results of power measurements on 531 new appliances in retail outlets (early 2001) and results of a national telephone survey of 801 households (December 2000) in Australia that documents information on appliance ownership, age and usage patterns.

This research revealed that 11.6% of Australia’s household electricity consumption can be attributed to energy used by appliances and electronic equipment when not performing their primary function (this figure includes some small continuous loads not traditionally classified as “standby”). This “standby” consumption was estimated in 2000 to be costing Australians more than \$500 million per year and generating more than 5 million tonnes of carbon dioxide per annum.

In addition to providing a more accurate estimation of the extent of power consumption from appliances in standby, the 2001 report revealed the need for ongoing research to

monitor the change in standby consumption of new appliances. In 2002 the first in an anticipated series of follow up surveys was conducted to fulfil this need. The report titled *Appliance Standby Power Consumption: Store Survey 2002* (EES and Energy Consult, 2002) measured energy consumption of 635 new appliances in retail outlets. This data was compared with the information recorded in the 2001 study, finding that while there appeared to be a slight decrease in standby power consumption overall, a large proportion of products still consumed more than 1W in standby and off modes, and an increasing number of appliances are manufactured with no hard off switch.

The results presented in this report provide details of in-store standby measurements for some 573 new household appliances that were undertaken in January 2003. This report represents a continuation of the ongoing monitoring of appliance standby power usage which began with the initial store survey conducted in early 2001.

Definition of “Standby”

Appliances and equipment with a “standby mode” may include any household product that consumes power while not performing its primary function. A simple definition of “standby” is when an appliance is at its lowest power consumption when connected to mains power, even if the appliance is turned off (lowest power mode that can be influenced by the user). However, “standby” is better defined under various modes and for the purpose of this research, standby modes were defined as follows:

Off

When a product or appliance is connected to a power source but does not produce any sound or picture, transmit or receive information or is



waiting to be switched “on” by the consumer. If the product has a remote control, it cannot be woken by the remote control from off mode. While the product may be doing some internal functions in off mode (e.g. memory functions, EMC filters) these are not obvious to the user.

Passive Standby

When a product or appliance is not performing its main function but it is ready to be switched on (in most cases with a remote control) or is performing some secondary function (e.g. has a display or clock). This mode also applies to power supplies for battery operated equipment (portable appliances which are intended to be used when disconnected from the base station) when the appliance is not being charged.

Active Standby

Active standby is mostly applicable to VCRs and some stereo equipment where operating involves some mechanical drive (such as DVD and CD players). Active standby is when the appliance on but not performing its main function. For example, the VCR may be on but is not playing or recording or a CD or DVD is on but not playing a disc. This mode also applies to power supplies for battery operated equipment (portable appliances) when the appliance is being charged (various sub-modes).

On

On mode was generally not measured for most products covered in this survey. On mode can be complicated by a range of factors (eg need for a load, detergent and plumbing for clothes washers, level of activities and peripherals on a computer, standardised tasks for audio and video equipment in terms of picture and/or sound). These conditions cannot be replicated in a retail environment and this mode is generally better covered by product specific test procedures as a rule. However, some indicative on mode measurements were undertaken, notably for digital set top boxes, home theatre AV receivers and AV receiver/DVD combos and televisions.

Aims & objectives

The Australian Greenhouse Office (AGO) and the National Appliance & Equipment Energy Efficiency Committee (NAEEEC) commissioned this research as part of its program to reduce the standby consumption of all electronic appliances to less than 1W. The main objectives of this survey were to:

- Quantify the magnitude of electricity used in standby mode by new appliances offered for sale in the Australian market in early 2003; and
- Compare the results of this study with those from the two previous in store surveys in order to track industry's progress in reducing standby power consumption.

In contrast to previous year's store surveys, information on the sale price of appliances was also collected. An analysis of standby power consumption in relation to the cost of the appliance was undertaken to determine if there is any relationship between poor standby performance and “budget” priced appliances and equipment.

Also new to this year's survey is recording whether products carried an Energy Rating label or an ENERGY STAR label as applicable. For those goods within the scope of the survey where an energy label is mandatory in Australia (clothes washers, dishwashers, clothes dryers, air conditioners) it was noted whether the product carried an energy label or not (not that refrigerators and freezers carry an energy label but these products do not have a standby mode). For those products that carried an ENERGY STAR label, the passive standby power reading was checked to see if it complied with the relevant requirements.

Research Methods

EQUIPMENT AND PREPARATION

The meter used for measuring the power consumption for most appliances was a Yokogawa¹ digital power analyser Model WT200. However, for a small number of appliances, where access was difficult, a smaller portable meter was used (Sparmeter Model NZR 230).

Four major Melbourne retail stores were approached to take part in the study, which allowed measurements of a large range of appliances across a number of manufacturers, to be taken. The metering device was systematically plugged into the floor stock across 29 appliances categories. There was no selection process, with most of the available stock on display in the store being measured. The reasons for some appliances on display not being measured as part of this survey were as follows:

- Appliance power cord missing;
- European or US power cord;
- Appliance difficult to access without disturbing the store display (this was particularly the case for some home theatre displays, plasma TVs and computers and peripherals);
- No display model available at the time;
- Appliance locked in cabinets for security reasons.

It should also be noted that products on display in retailers have had their software and/or hardware altered from the normal default values

and so in some cases these may not fully representative of the standby performance of the particular product (mostly applicable to some types of audio equipment and video equipment.)

Appliance brand and model number were recorded to prevent duplication of measurements.

For each appliance, power consumption was measured while the appliance was in use, in standby (passive and/or active) and off, where applicable. Clearly for many appliances such as washing machines and dishwashers, it was impractical to measure the appliance in use. For most of these products there is an Australian Standard that adequately covers the 'in use' mode consumption.

For televisions and VCRs power factor, crest factor and supply voltage information was also recorded during measurements.

Power factor traditionally means any phase shift between a sinusoidal voltage supply waveform and a sinusoidal current waveform (power factor is 1.0 when these are perfectly aligned). However, in the case of standby measurements where the current waveform is often distorted and non-sinusoidal in shape, the power factor is the ratio of the active power (Watts) to the average apparent power (or VA: volt-amps). The power factor is a measure of how much of the current is performing useful work (contributing to active power use). Subjective assessments for power factor are low <0.5, moderate 0.5-0.8, high >0.8-1.0.

The crest factor is defined as the ratio of peak current to RMS current (or peak voltage to RMS voltage). For a pure sinusoidal waveshape

¹ Calibrated in February 2002. Fundamental power accuracy of 0.25%. The Sparmeter has been found to have a high level of accuracy for a wide range of standby loads.



Table 1 – A summary of modes tested by appliance type for this survey

Appliance List	In Use	Active Standby	Passive Standby	Off
Air Conditioner				✓
Breadmaker		✓		✓
Computers – Box				✓
Computers - Laptop				✓
Computers - Monitor				✓
Digital Set Top Box	✓		✓	
Dishwasher				✓
Dryer				✓
DVD & VCR Player		✓	✓	✓
DVD Player		✓	✓	✓
DVD Recorder		✓	✓	
Espresso Machine		✓		✓
Hand-held Vacuum *		✓	✓	
Home Theatre - AV Receiver	✓		✓	✓
Home Theatre - AV Receiver/DVD	✓		✓	✓
Home Theatre - Subwoofer		✓		✓
Microwave**			✓	
Printer – Inkjet			✓	✓
Printer – Laser			✓	✓
Stereo – Integrated		✓	✓	
Stereo – Portable		✓	✓	
TV – LCD	✓		✓	✓
TV – Plasma	✓		✓	✓
TV – Projection	✓		✓	✓
TV – standard	✓		✓	✓
TV/VCR	✓	✓	✓	✓
VCR		✓	✓	✓
Washer/Dryer				✓
Washing Machine				✓
Mode tested ✓				

Note: * Battery operated appliances, passive = no battery charging, active = with battery charging.

the crest factor is 1.414, while for a pure constant DC load the crest factor is 1.0. The parameter of particular concern from a metering perspective for standby power is the current and its waveform. During the measurement, it is critical that the crest factor available on the meter is greater than the actual crest factor of the load; otherwise the peak value of the current could be “lopped off”. Note that the current crest factors for standby loads are typically 3 and can be as high as 10 in some circumstances. Crest factor is a measure of the

level of distortion of the current waveform (and the difficulty in performing an accurate power measurement). Subjective assessments for crest factor are low <2.5, moderate 2.5-4, high >4.

As indicated in Table 1, appliances were measured in various combinations of in-use, standby (passive or active, where applicable) and off mode. As previously mentioned it was not always practical to measure appliances in normal use during an in store survey. The

modes measured for each product type reflect the design and operation of the product. While some products types will have passive or active standby modes (e.g. a dishwasher can usually be switched on prior to the start of a program – this would be passive standby), not all of these modes were measured or are relevant to this study.

In total 573 products were measured resulting in 1026 measurements being recorded during the survey. These results were analysed and compared with outcomes from the 2001 and 2002 in-store survey as far as possible.

PROBLEMS ENCOUNTERED DURING DATA COLLECTION

Not all products could be measured in all of the desired modes. For example, security reasons prevented many remote controls being displayed with items. As a result, appliances reliant on remote controls for operation into some modes were unable to be measured across all modes. Additionally comparisons with previous surveys are not possible due to the changing market, for example in 2003 individual stereo components were not found in retail outlets, having been replaced in the market by home theatre systems.

Other problematic appliances included stereo units, such as integrated stereo equipment, where active standby power varied depending on the part of the unit “waiting to be used”. For example, active standby could be higher for some units when a CD was present (but not playing) within the unit. To overcome the variation in standby measurements for integrated stereo equipment, measurements were taken in CD mode when the unit had finished searching for the disc. In most units a “No Disc” message was displayed. For integrated stereo equipment without a CD player, measurements were taken with the unit set to tuner. Many stereo components did not appear to have an off mode.

ACKNOWLEDGEMENTS

This study was undertaken by Energy Efficient Strategies (Victoria) and EnergyConsult (Victoria) for the National Appliance and Equipment Energy Efficiency Committee. The study was managed for NAEEEEC by the Sustainable Energy Group of the Australian Greenhouse Office.

A number of organisations assisted with this project and their cooperation and assistance is gratefully acknowledged. We would like to particularly thank management and staff of the following Melbourne stores:

- Dick Smith Powerhouse, Maribrynong;
- The Good Guys, Maribrynong;
- Harvey Norman Electrical, Maribrynong;
- Newtowne's Retravision, Footscray.

The study was coordinated by Paula Kleverlaan of EnergyConsult with support from Lloyd Harrington of Energy Efficient Strategies. Melissa Damnic, Michelle Fincke and Nedd Wellyn Jones of EnergyConsult were responsible for undertaking field measurements on appliances and the recording of data. Paul Ryan of EnergyConsult was responsible for setting up the data collection instrument used in the field and subsequent data analysis software. Paula Kleverlaan and Lloyd Harrington conducted additional analysis of data from previous standby surveys. Paula Kleverlaan, Melissa Damnic and Lloyd Harrington were responsible for the preparation of the main report. Dianne Glass of EES formatted and typeset the final report.

Notwithstanding the many individuals and organisations that have assisted during this project, the content and form of this report, and all of the views, conclusions and recommendations expressed in it, are those of Energy Efficient Strategies and EnergyConsult.



Results

Overview

The following 28 appliance types were tested during the 2003 in store survey:

- Air Conditioner
- Breadmaker
- Computers - Box
- Computers - Laptop
- Computers - Monitor
- Dishwasher
- Dryer
- DVD & VCR Player
- DVD Player
- DVD Recorder
- Espresso Machine
- Hand-held Vacuum
- Home Theatre - AV Receiver
- Home Theatre - AV Receiver/DVD
- Home Theatre - Subwoofer
- Microwave
- Printer - Inkjet
- Printer - Laser
- Stereo - Integrated
- Stereo - Portable
- TV - LCD
- TV - Plasma
- TV - Projection
- TV - Standard
- TV/VCR
- VCR
- Washer/Dryer
- Washing Machine

The survey had also intended to measure CD writers, mobile phones, scanners and modems but found that for security reasons these items were displayed in locked cabinets and in the case of mobile phones, usually without chargers. Security also prevented testing of all models on display in the electrical product groups as the newer shop fixtures allow power cords to be secured behind screwed in panels. Portable electric heaters were also to be measured, however these items are only stocked on a seasonal basis and were not in stores during the survey (January 2003).

The following sections details the results by appliance type.

Product Summaries

MAJOR APPLIANCES

Air Conditioners

A total of 26 air conditioner units were measured; 5 were window-wall models, 2 were split systems and the other 19 portable appliances. Eleven of the portable units used evaporative cooling. Of the 26 air conditioners measured, 6 displayed an Energy Rating label and 5 of these were displayed on refrigerated window-wall models. The remaining unit was a refrigerated portable air conditioner. Note that evaporative models do not require an energy label.

The in store survey measured air conditioners in off mode only. The majority of these appliances had an off switch on the unit, with very few having remote operation. The average power consumption in off mode was 0.6W with 4W being the highest and 0.0W the lowest. The results for air conditioners are summarised in Table 2 below.

Table 2 – A summary of air conditioner results - 2003

Appliance:		Air Conditioner			
Mode	No. of Measurements	Av Power (W)	Power Max	Power Min	
Off	26	0.6	4.0	0.0	
Total No. of Units	26				

Figure 1 presents the data recorded for air conditioners during the annual surveys undertaken thus far. The 2003 figures indicate an improvement in the proportion of models with no consumption in off mode. However, when looking at the distribution there appears to be a trend of increasing consumption. In 2003, 23% of units consumed greater than one watt compared with only 10% in 2002. The maximum consumption recorded in 2003 (4W) was more than double the maximum in 2002 (1.9W). The type of air conditioner appears to have no affect on consumption in off mode, although the four models that consumed the most power were all refrigerated units. Air conditioners were not measured in the 2001 survey.

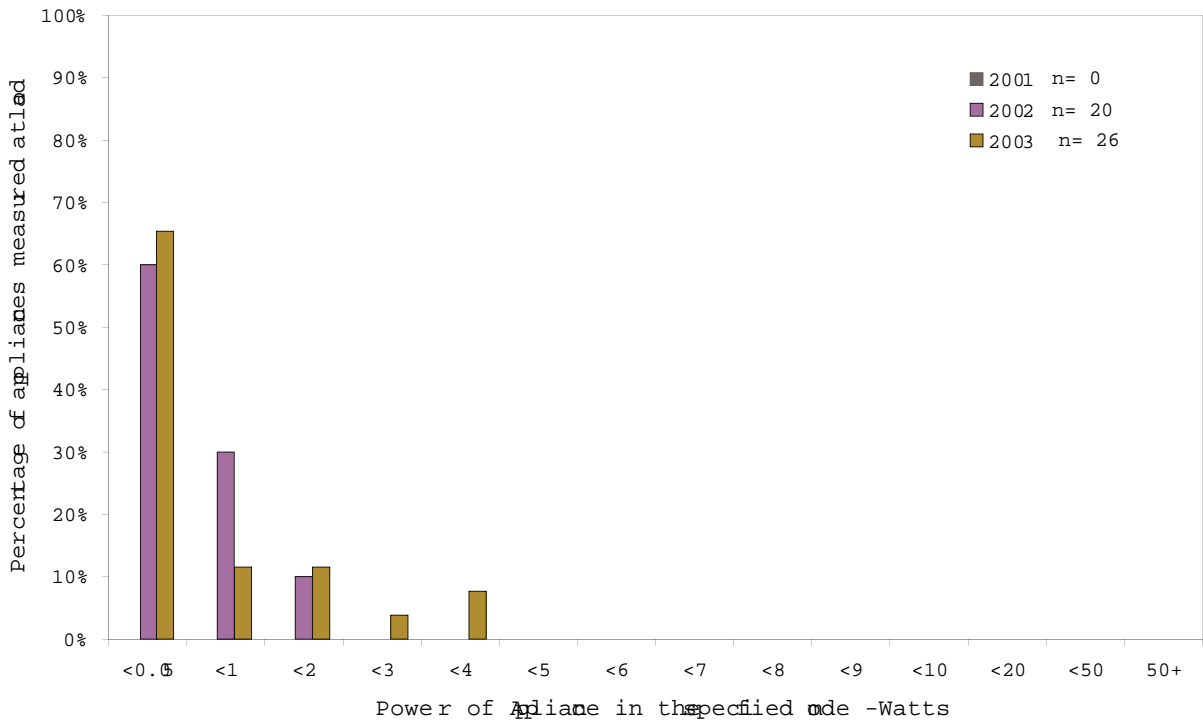
Trends in standby are shown in Table 3.

Table 3 – Trends in standby for air conditioners

Mode	Power (W) 2001	Power (W) 2002	Power (W) 2003
Off	NA	0.4	0.6



Figure 1 – Power measurements for air conditioners: off mode



Note: Histograms included in this report generally use the same bin definitions, except where otherwise noted. The first bin indicates the number of units with no power consumption in the mode specified (i.e. equal to 0.0 Watts, or effectively less than 0.05 Watts in terms of metered data). The second bin is the number of appliances with >0.0 Watts but less than 1.0 Watts. The third bin is the number of appliances with greater than or equal to 1.0 Watts and less than 2.0 Watts and so on. Note that bin sizes for > 10 Watts are non linear.

An important point to note regarding air conditioners is that the most popular type of air conditioners are split systems (many of this type use remote controls and will therefore have some standby) and almost all are “hard wired”, so in-store measurements were not possible. Lab measurements (e.g. during energy labelling and MEPS tests) will be necessary to collect data for this type of air conditioner.

The intrusive survey conducted in late 2000 measured off mode data for 9 air conditioners installed in residential houses (most were window wall units – split systems were inaccessible). Average off mode power for these models was 0.1W.

Clothes Dryers

The survey measured 11 clothes dryers in total. All units displayed an Energy Rating label. These appliances generally do not have an on/off switch as such with the exception of one

unit which was measured in off mode only. The average power consumption was 0.4W with the maximum reading being 2.6W and the minimum zero. Table 4 below summarises the results for clothes dryers.

Table 4 – A summary of clothes dryer results - 2003

Appliance:		Dryer		
Mode	No. of Measurements	Average Power (W)	Power Max	Power Min
Active	1	3.9	3.9	3.9
Off	11	0.6	2.5	0.0
Total No. of Units	11			

As presented in Figure 2 below the vast majority of clothes dryers consume less than 1W in off mode. 70% of units measured in 2003 consume zero energy when in off mode and only two models consume greater than 1W. While the number of measurements for this appliance type is small, it would seem there might be a trend of decreasing standby consumption. The proportion of 2003 models with zero consumption is more than double the 2001 results. In contrast with this, the range of results over the three years has been almost identical, with 0.0W being the minimum and 2.9W, 2.6W and 2.5W the maximum consumption recorded in each of the three years respectively. Additionally, the intrusive survey in 2000 measured off mode data for 35 clothes

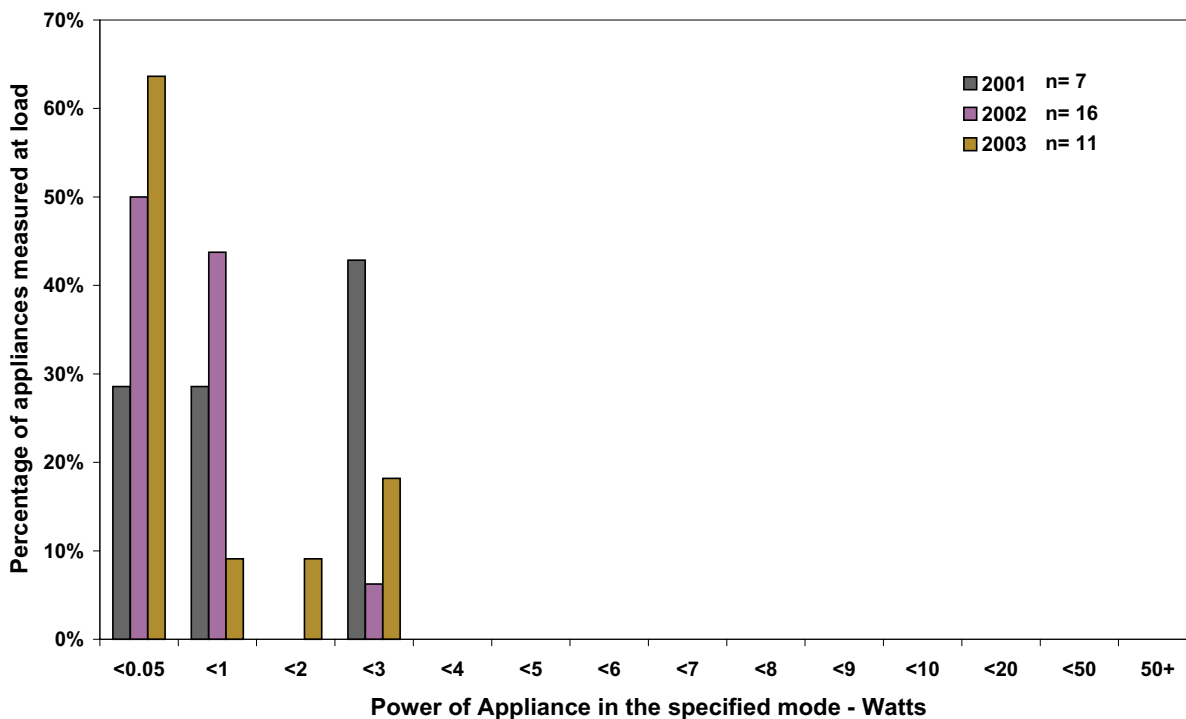
dryers installed in residential houses. Average off mode power for these models was 0.4W. The results have not been sales weighted by share of model sales.

Trends in standby are shown in Table 5.

Table 5 – Trends in standby for clothes dryers

Mode	Power (W) 2001	Power (W) 2002	Power (W) 2003
Off	1.2	0.3	0.6

Figure 2 – Power measurements for clothes dryers: off mode



Clothes Washer/Dryers

Clothes washer-dryers are units that are capable of both washing and drying clothes in single or separate cycles. A total of 3 washer-dryers from different manufacturers were tested in this survey and all displayed Energy Rating labels. Two models were front loaders with a power on/off switch. They were tested in off and active standby mode. Two machines recorded less than 1W power consumption when in off. In active standby one of the two machines consumed less than 1W. A summary of these results can be found in Table 6.

Table 6 – A summary of clothes washer/dryer results - 2003

Appliance: Washer/Dryer				
Mode	No. of Measurements	Average Power (W)	Power Max	Power Min
Active	2	3.3	6.0	0.6
Off	3	1.2	3.5	0.0
Total Number of Units	3			

Trends in standby are shown in Table 7.

Table 7 – Trends in standby for clothes washer/dryers

Mode	Power (W) 2001	Power (W) 2002	Power (W) 2003
Off	0.2	0.1	1.2

Dishwashers

During the survey 27 dishwashers were measured and all displayed Energy Rating labels. The operating controls on the dishwashers varied, with some having mechanical dials while others had soft touch electronic controls. A small minority of units did not have a power on/off button.

These appliances were measured only in off mode. Power consumption ranged from 0.0W to 4.5W with the average being 1W. Table 8, below summarises the in store results for dishwashers.

Table 8 – A summary of dishwasher results - 2003

Appliance: Dishwashers				
Mode	No. of Measurements	Average Power (W)	Power Max	Power Min
Off	27	1.0	4.5	0.0
Total No. of Units	27			

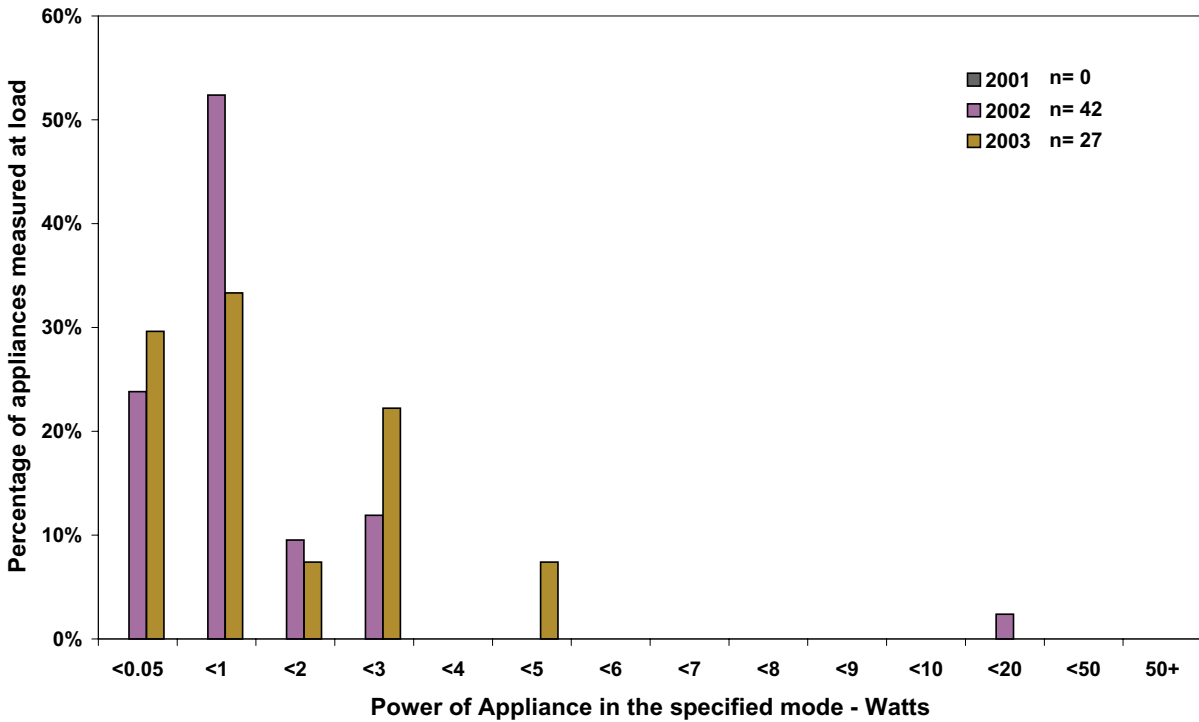
Figure 3 demonstrates that while 76% of dishwashers in the 2002 survey consumed less than 1W this was true for only 63% of models in the 2003 survey. The 2003 results show a slight increase in the proportion of dishwashers with no consumption, however average consumption rose a little from 0.8W in 2002 to 1W in 2003. These increases may be due to a greater number of models having electronic controls rather than manual dials. However, as noted previously with so many dishwashers recording consumption of less than 1W it is reasonable to expect that the higher standby models could be performing better. The results have not been sales weighted for brand share.

Trends in standby are shown in Table 9.

Table 9 – Trends in standby for dishwashers

Mode	Power (W) 2001	Power (W) 2002	Power (W) 2003
Off	NA	0.8	1.0

Figure 3 – Power measurements for dishwashers: off mode



Washing Machines

The washing machine category includes both top loading models and front-loading machines. The machines also varied in their rated capacity and some machines had power on/off switches. All but two of the machines measured displayed an Energy Rating label.

In total, 62 washing machines were tested in the store survey. All machines were measured in off mode and those models with an on/off switch were measured in active standby. In active mode the average power was 3.3W with most machines (61%) consuming between 2W and 5W. In off mode the range of consumption was 0W to 5.1W with an average consumption of 1W. For summary of these results see Table 10.

Table 10 – A summary of washing machine results - 2003

Appliance: Washing machine				
Mode	No. of Measurements	Average Power (W)	Power Max	Power Min
Active	26	3.5	6.3	1.7
Off	62	1.3	9.2	0.0
Total No. of Units	62			

As demonstrated in Figure 4 over half (55%) the washing machines in 2003 consumed less than 1W when in off mode, which is down from 73% in 2002. There was an increase in the proportion of models recording zero consumption, up from 36% in 2002 to 45% in 2003. After the 2002 survey it was discovered that one brand of washing machine had a 20 minute power down cycle for its newer models. The manufacturer provided an override procedure, which was used for the 2003 survey: this accounts for the decrease in models

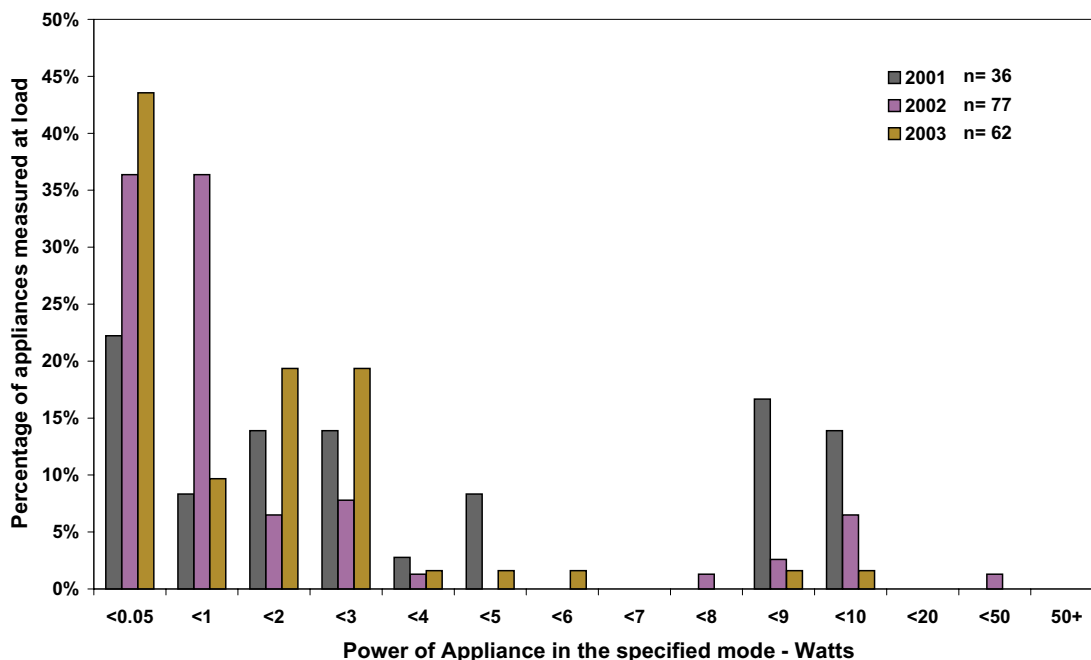
consuming more than 7W (the 2002 results should have been a mix of 1.5W and >7W variants – however they were all recorded as the higher value). There were still two models in 2003 that consumed over 7W, however, these were removed from the dataset for analysis as it was initially thought that these machines were faulty as they could not be put into off mode (it was subsequently discovered that these were old models and that the measurements were in fact accurate). With these two models included, the average off mode power is 1.2W, which is still a trend downwards from 2002 and 2001. Note that the off mode values for 2002 and 2001 have not been adjusted to take into account the old and new variants present in the sample in that year (accurate measurements are not available). The growth in the number of models with no consumption would seem to indicate that those models with consumption greater than 1W should be able to improve their performance. Trends in standby are shown in Table 11.

Table 11 – Trends in standby for washing machines

Mode	Power (W) 2001	Power (W) 2002	Power (W) 2003
Off	3.8	1.7	1.3

A comparison of the average power consumption of washing machines indicates that average off mode consumption has reduced from 1.7W in 2002 to 1.0W in 2003. However, this result is not statistically significant² indicating that the decrease in standby consumption observed from the 2001 data has been sustained rather than continued. Generally front loaders have had a low off mode consumption (typically 0.15W); however front loader sales are less than 15% of total sales. Front loaders made up 35% of the 2003 sample and nearly 50% of the 2002 sample. The results have not been sales weighted for brand share or type of unit.

Figure 4 – Power measurements for washing machines: off mode



Note: Models with off mode consumption of >7W in 2002 and 2001 may include models with actual off mode power of around 1.5W.

² Throughout this report, significance has been tested at the 95% confidence level.

SMALL APPLIANCES

Breadmakers

Most breadmakers when switched on are in active standby as a display is lit up and the machine is awaiting instructions from the user. In 2002, one unit was found to have a power on/off button although no units in 2003 had an on/off button. The units were measured in active standby mode only. The average power used by breadmakers in active standby mode was 1.8W with a low of 1.1W and a high of 2.9W. Table 12 below summarises the results for breadmakers.

Table 12 – A summary of breadmaker results - 2003

Appliance: Breadmaker		No. of Measurements	Average Power (W)	Power Max	Power Min
Mode	Off	15	1.8	2.9	1.1
Total No. of Units		17			

Note: 2 units had an active power recorded as 0.0W but these were considered to be data entry errors.

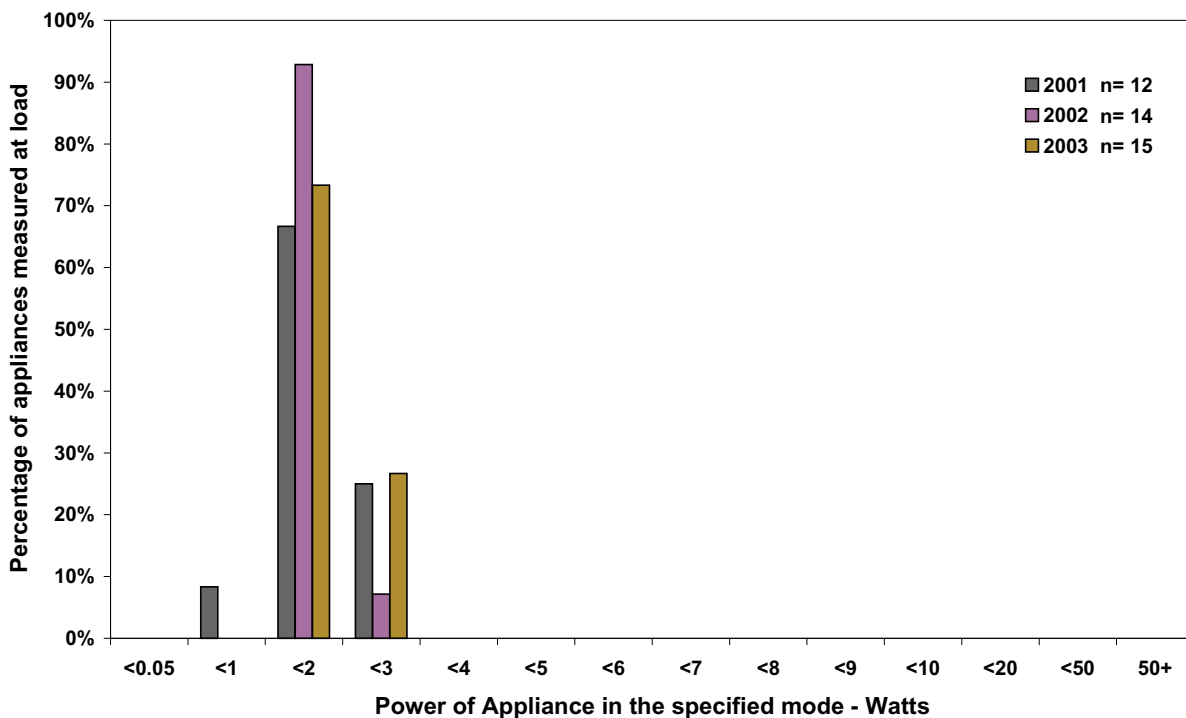
With a very small sample size, it is difficult to predict trends with any certainty, however Figure 5 indicates that power consumption for breadmakers in active standby is relatively stable with most consuming less than 2W. In the 2002 survey the average power consumption recorded for breadmakers was 1.5W in active standby mode. In 2001 the average was 1.8W. This further indicates that the power consumption for this appliance has remained fairly stable.

Trends in standby are shown in Table 13.

Table 13 – Trends in standby for breadmakers

Mode	Power (W) 2001	Power (W) 2002	Power (W) 2003
Off	1.6	1.5	1.8

Figure 5 – Power measurements for breadmakers: off mode



Hand-held Vacuum cleaners (“dustbusters”)

A total of 18 hand-held vacuum cleaners were measured during the in-store survey. The most obvious differences that exist between models are based on size and whether the unit can vacuum wet as well as dry.

The hand-held vacuum cleaners were measured in active standby, that is, plugged in and charging, and in passive standby, with the base station plugged in but not charging the portable unit. Three of the units measured didn't appear to be charging then they were plugged in and switched on, therefore a lower reading was recorded for these appliances compared to others measured (note that the power measured during battery charging (active standby mode) depends on the state of charge of the battery and the design of the charger, so results for this mode need to be treated with some caution). On average the units were found to consume 3.2W when charging, with the maximum consumption of 8.1W and a minimum of 1.1W. When in passive standby the units recorded an average power consumption of 1.1W with a low of 0.8W and a high of 1.7W (typical of transformer standing losses of the low voltage power supply). These results are summarised below in Table 14.

Table 14 – A summary of hand-held vacuum cleaner results - 2003

Appliance:		Hand-held Vac		
Mode	No. of Measurements	Average Power (W)	Power Max	Power Min
Active	17	3.2	8.1	1.0
Passive	18	1.1	1.7	0.8
Total No. of Units	18			

Figure 6 below shows the distribution of measurements for hand-held vacuum cleaners in active standby mode for the years 2001, 2002 and 2003. The graph demonstrates there has been little change over the years in standby consumption, although one model in 2003 did produce a reading on 8.1W in standby, which is higher than any reading in previous years. The majority of hand-held vacuum cleaners use less than 3W when in active standby.

The average power consumption for hand-held vacuum cleaners in active standby has remained stable over the past three years at around 3.3W.

Trends in standby are shown in Table 15.

Table 15 – Trends in standby for hand held vacuum cleaner

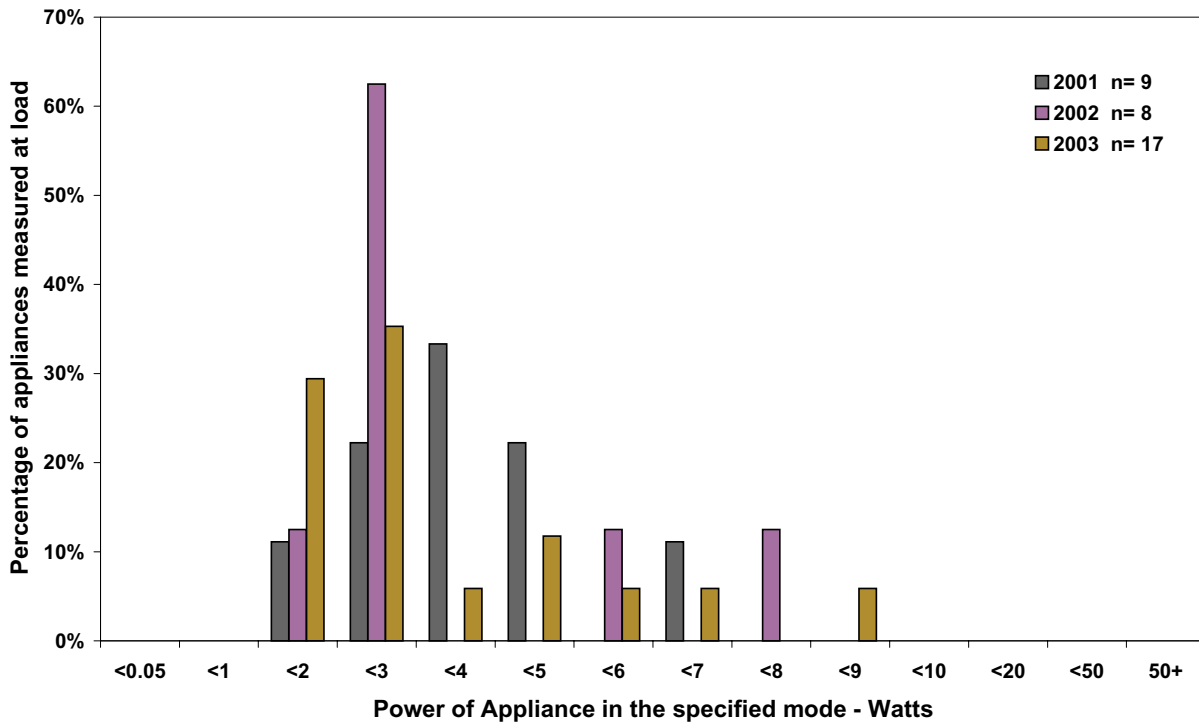
Mode	Power (W) 2001	Power (W) 2002	Power (W) 2003
Active	3.6	3.3	3.2
Passive	1.0	0.9	1.1

In passive standby mode most hand-held vacuum cleaners consumed less than 2W and this is consistent over the years as shown in Figure 7 below. Average passive standby for each of the years has also remained stable at around 1.0W.

The intrusive survey in 2000 measured off mode data for 29 hand-held vacuum cleaners installed in residential houses. Average passive standby mode power for these models was 1.3W while the active standby power was 3.3W. The trend in passive and active standby mode power consumption appears to be stable.

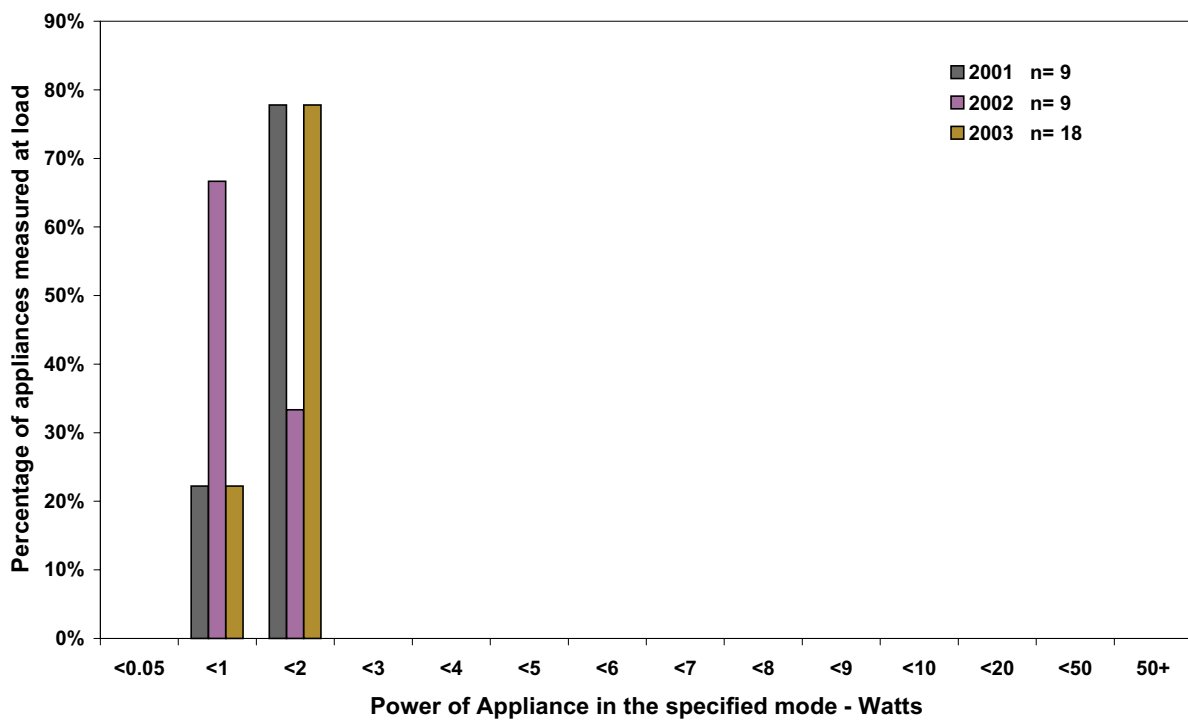


Figure 6 – Power measurements for hand-held vacuum cleaners: active standby mode



Note: The power measured during battery charging (active standby mode) depends on the state of charge of the battery and the design of the charger, so results for this mode need to be treated with some caution.

Figure 7 – Power measurements for hand-held vacuum cleaners: passive standby mode



Microwave Ovens

The majority of microwave ovens measured in the store surveys have a digital clock display and electronic controls. A very small number rely totally on mechanical controls (only two units in this year's sample). The microwaves varied in size and included both combined convection/microwave and microwave only models.

Microwave ovens were measured in passive standby mode only (even though, strictly speaking, models with mechanical controls should be classified as off mode). As demonstrated below in Table 16 the average power measured for microwaves was 3.1W with a minimum of 0.1W and a maximum of 6.2W.

Table 16 – A summary of microwave results - 2003

Appliance: Microwave				
Mode	No. of Measurements	Average Power (W)	Power Max	Power Min
Passive	40	3.1	6.2	0.1
Total No. of Units	40			



microwaves in passive standby mode. The distribution shows that in 2002, standby consumption was trending downwards with a greater proportion of units consuming less than 3W compared to 2001. However, this improvement was not sustained into 2003 with many units falling into the <5W category. Average passive standby consumption improved (i.e. decreased) significantly between 2001 and 2002 with average consumption recorded at 3.5W and 2.7W for each year respectively. However, average consumption rose again in 2003 (3.1W) and statistical significance is no longer noted between 2001 and 2003. The intrusive survey in 2000 measured off mode data for 44 microwave ovens installed in residential houses. Average passive standby mode power for these models was 3.9W.

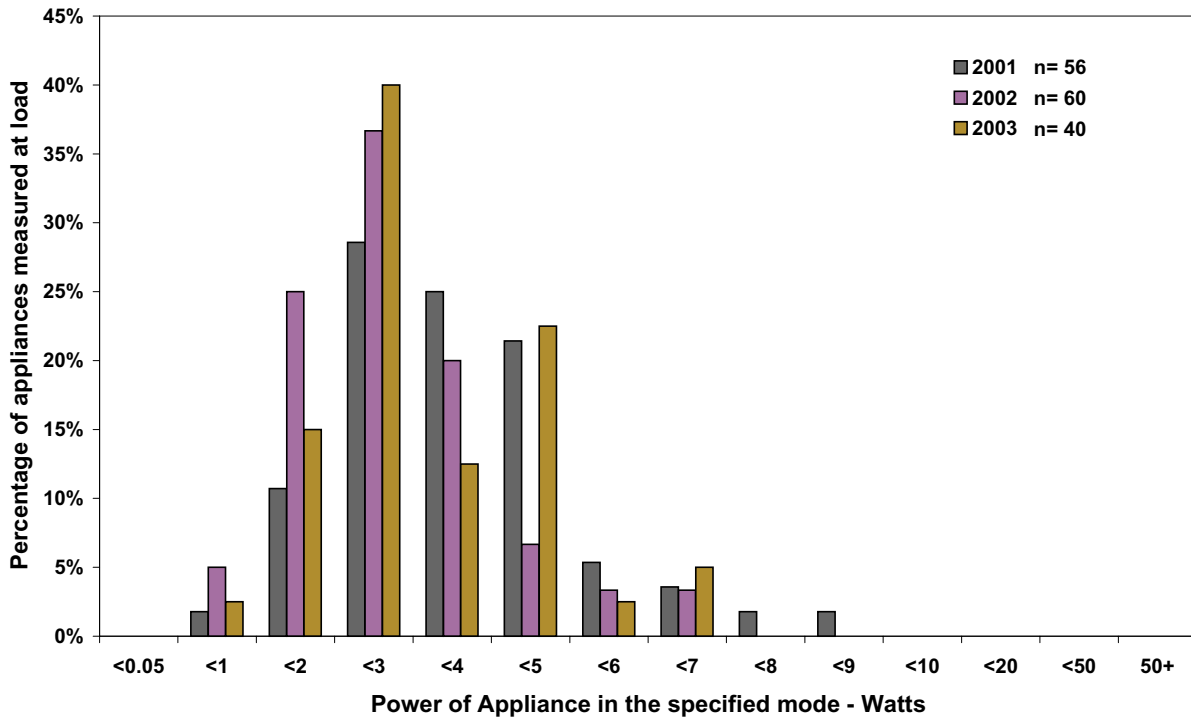
It appears that passive standby consumption is potentially decreasing for microwaves, although until data is collected in forthcoming years it may be premature to indicate that an improving trend is emerging.

Trends in standby are shown in Table 17.

Table 17 – Trends in standby for microwaves

Mode	Power (W) 2001	Power (W) 2002	Power (W) 2003
Passive	3.5	2.7	3.1

Figure 8 – Power measurements for microwaves: passive standby mode



Espresso Machines

This year is the first year that espresso machines have been measured in the store survey. Given their rise in popularity and the proliferation of machines now available it was considered important to include espresso machines in the survey. The espresso machines measured do not include drip filter type coffee machines and all were labelled “espresso machine” by the manufacturer. Espresso machines are either pump operated or steam operated and both are able to froth milk. Steam machines are less expensive to buy than pump machines.

Twelve espresso machines were measured in the survey including both a mixture of pump operated and steam operated machines. All were measured in off mode and in active standby mode. In active standby, the machines are warming up and preparing to make coffee.

Of the 12 machines measured, a wide variation in the results were noticed in off mode. While

the majority measured 0.0 Watts in off mode, one machine measured a very high figure of 12.5W when off. Another measured 4.65W and two others 1.8W. The average power in off mode was 1.8W.

In active standby, all machines consumed a great deal of energy. This is to be expected as the machine is warming up at a fast rate to make coffee and drawing a lot of power to do so. While the espresso machine is not technically “on” in that it is not making coffee at this stage, we could assume that the power drawn in the active standby mode would be similar to power drawn when the machine is in use. Average power of espresso machines in active standby was 1,058W. This has implications for standby power policy if consumer usage indicates that espresso machines are left on, rather than turned off at the unit (or at the wall) (it is also unclear what their power consumption would do over a period of hours, for example). The only insights we have into consumer behaviour in relation to coffee machines (as distinct from

espresso machines) is from the NAEEEEC sponsored appliance usage survey undertaken in late 2000. Respondents in this survey were asked about the current status of their coffee machines and 12% revealed that their machines were “on”. The remainder (88%) were “off”. The limitations of these results are that respondents were not asked about espresso machines specifically nor were they asked how long ago the last coffee was made (indicating that the machine had been used and that the respondent had failed to turn it off). Further research needs to be conducted to determine if consumer behaviour is lax towards turning off their espresso machines and if so, policy options to reduce power consumption (such as a shut-off switch after 10 minutes of inactivity³) need to be investigated.

Table 18 below summarises the results for espresso machines.

Table 18 – A summary of espresso machine results - 2003

Appliance: Espresso Machine				
Mode	No. of Measurements	Average Power (W)	Power Max	Power Min
Active	12	1,058	1,310	818
Off	12	1.8	12.5	0.0
Total No. of Units	12			

COMPUTERS AND PERIPHERALS

Computers - Hard Drive/CPU Box

A total of 20 computers were included in the in store survey. The measurements included only the hard drive/CPU box with peripherals such as monitors and printers measured separately. None of the products measured displayed an ENERGY STAR label. Portable/laptops were measured separately and are reported on in the following section.

Computers were measured in off mode only as active and passive operating modes for computers are complex and are dependent on hardware and software settings. In addition, these modes are adequately covered by existing standby related programs such as ENERGY STAR.

The average off mode power consumption was 3.6W with the highest consuming unit using 6.3W and the lowest using 1.8W. These results are summarised in Table 19 below.

Table 19 – A summary of Hard Drive/CPU Box results - 2003

Appliance: Computers- Box				
Mode	No. of Measurements	Average Power (W)	Power Max	Power Min
Off	20	3.6	6.3	1.8
Total No. of Units	20			

³ It should be noted that the survey did not measure the units after ten minutes of active standby, so it is not known whether the units “power down” after a specified amount of time.

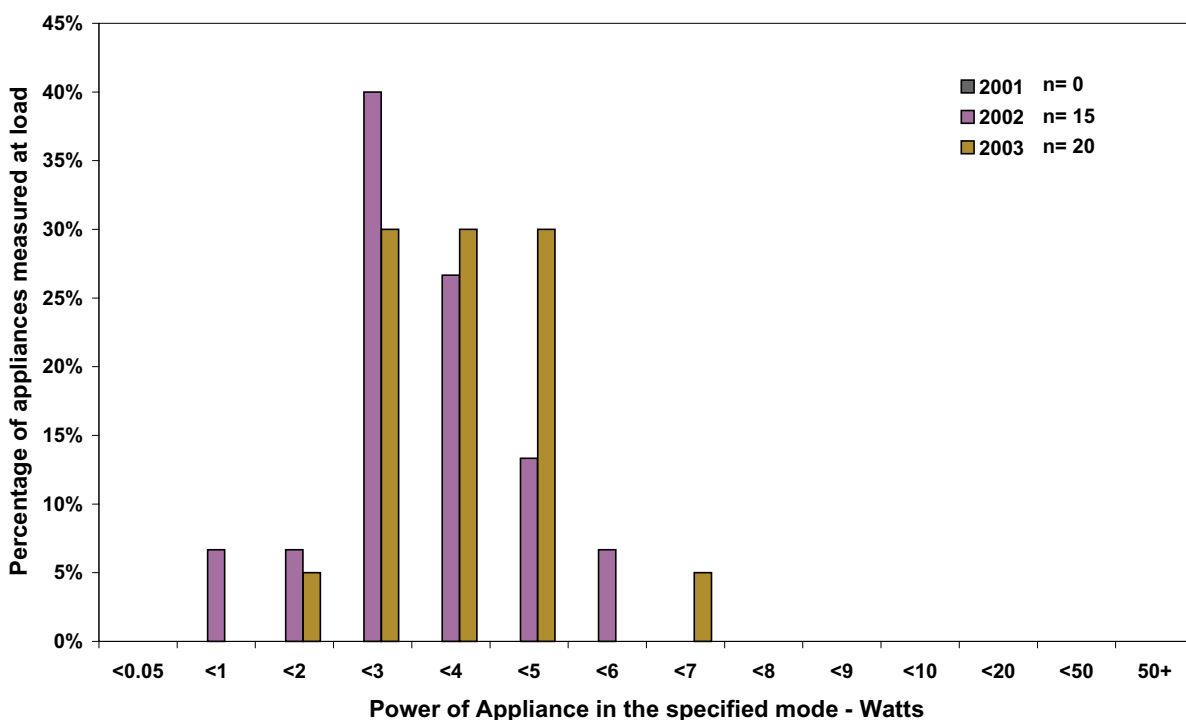
As illustrated in Figure 9, the majority of computers consume between 2W and 5W in off mode. All computers in the 2003 survey consumed more than 1W in off mode. While not statistically significant, there was a slight increase in the average power consumption at 3.6W in 2003, up from 2.9W in 2002. As previously noted, there have been recent changes in PC power supply design and configuration which has increased off mode consumption.

Trends in standby are shown in Table 20.

Table 20 – Trends in standby for computers box

Mode	Power (W) 2001	Power (W) 2002	Power (W) 2003
Off	NA	2.9	3.6

Figure 9 – Power measurements for computers: off mode



Computers- Portable/Laptop

A total of 9 portable computers were included in the in store survey. None of these displayed an ENERGY STAR label. The units were measured in off mode only. Off mode for laptops is with the power supply on but the laptop disconnected. A minimum power consumption of 0.9W was recorded with an average consumption of 1.4W. While only 2 models used less than 1W, 78% consumed less than 2W. This is the first year portable computers have been measured. The results are summarised in Table 21 below.

Table 21 – A summary of portable computer results - 2003

Appliance: Computers-Laptop				
Mode	No. of Measurements	Average Power (W)	Power Max	Power Min
Off	9	1.4	2.4	0.9
Total No. of Units	9			

Computer Monitors

The survey measured 14 computer monitors in off mode only. None of the monitors measured displayed an ENERGY STAR label. The average power consumption was 2.6W with a minimum of 0.0W and a maximum of 6.3W. The sample included two flat screen monitors that recorded off consumption in the mid range, being 3W and 1.5W. The results for computer monitors are summarised in Table 22 below.

Table 22 – A summary of computer monitor results - 2003

Appliance: Computers Monitors				
Mode	No. of Measurements	Average Power (W)	Power Max	Power Min
Off	14	2.6	6.3	0.0
Total No. of Units	14			

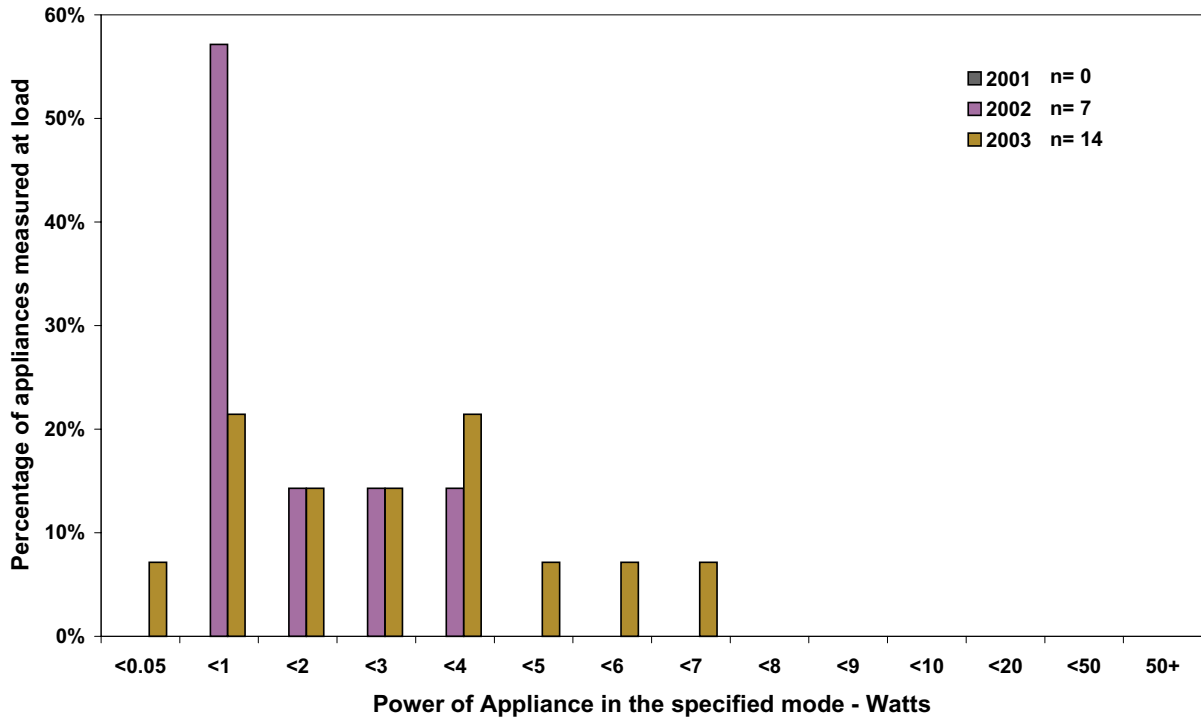
Figure 10 indicates that, with one exception, all monitors were found to consume some power in off mode, with most consuming more than 1W. The range in consumption has expanded since 2002 when a minimum of 0.1W and a maximum of 3.6W were recorded. Additionally, the average power consumption has more than double from 1.2W in 2002 to 2.6W in 2003. The intrusive survey in 2000 showed off mode consumption for monitors purchased prior to 1995 was rare. The trend in off mode power consumption appears to be increasing when considering the characteristics of the installed stock and the fact that all new models appear to have some off mode power consumption. The reasons for this are unclear. Only 2 of the 14 units were LCD flat screen units with an external power supply (these are expected to have some off mode consumption associated with the external power supply). However, with the small numbers of monitors tested it is not possible to suggest any definite trends.

Trends in standby are shown in Table 23.

Table 23 – Trends in standby for computers monitors

Mode	Power (W) 2001	Power (W) 2002	Power (W) 2003
Off	NA	1.2	2.6

Figure 10 – Power measurements for monitors: off mode



Printers – Inkjet

A total of 15 inkjet printers were tested during the in-store survey. None of the printers measured displayed an ENERGY STAR label. The units were differentiated by the quality of print they were able to produce and the speed at which they could print.

During the survey inkjet printers were measured in off mode and in passive standby mode - that is, switched on ready to print (but not printing). Three models did not have a power on/off switch and one unit had a broken switch so no off mode could be recorded. When in passive standby the average power consumption was 6W. However the highest power consumption was 10.7W and the lowest was 1.3W. In off mode the average power was 2.4W with a maximum of 6W and a minimum of 0.0W. Table 24 summarises these findings.

Table 24 – A summary of inkjet printers results - 2003

Appliance:		Printer - Inkjet			
Mode	No. of Measurements	Average Power (W)	Power Max	Power Min	
Passive	13	6.0	10.7	1.3	
Off	11	2.4	6.0	0.0	
Total No. of Units	15				

The power measurements for inkjet printers in passive mode are displayed in Figure 11. In 2003 there has been little change in the passive mode consumption with all printers consuming more than 1W. Average power consumption has remained stable (5.5W in 2002, 6W in 2003).

Trends in standby are shown in Table 25.

Table 25 – Trends in standby for inkjet printers

Mode	Power (W) 2001	Power (W) 2002	Power (W) 2003
Passive	NA	5.5	6.0
Off	NA	3.0	2.4

Figure 13 presents the power consumption results for inkjet printers in off mode. Unlike the 2002 survey, two units recorded zero consumption in off mode in 2003. However, overall there is little difference between the results in 2002 and 2003 with both years producing a similar range and distribution of the data. Furthermore, average power consumption for both years is in line with the results gained from the survey of the installed stock (stock = 3W in 2000, 3W for new in 2002 & 2.4W for new in 2003). These results indicate the trend for Inkjet printers in off mode is stable.



Figure 11 – Power measurements for inkjet printers: passive standby mode

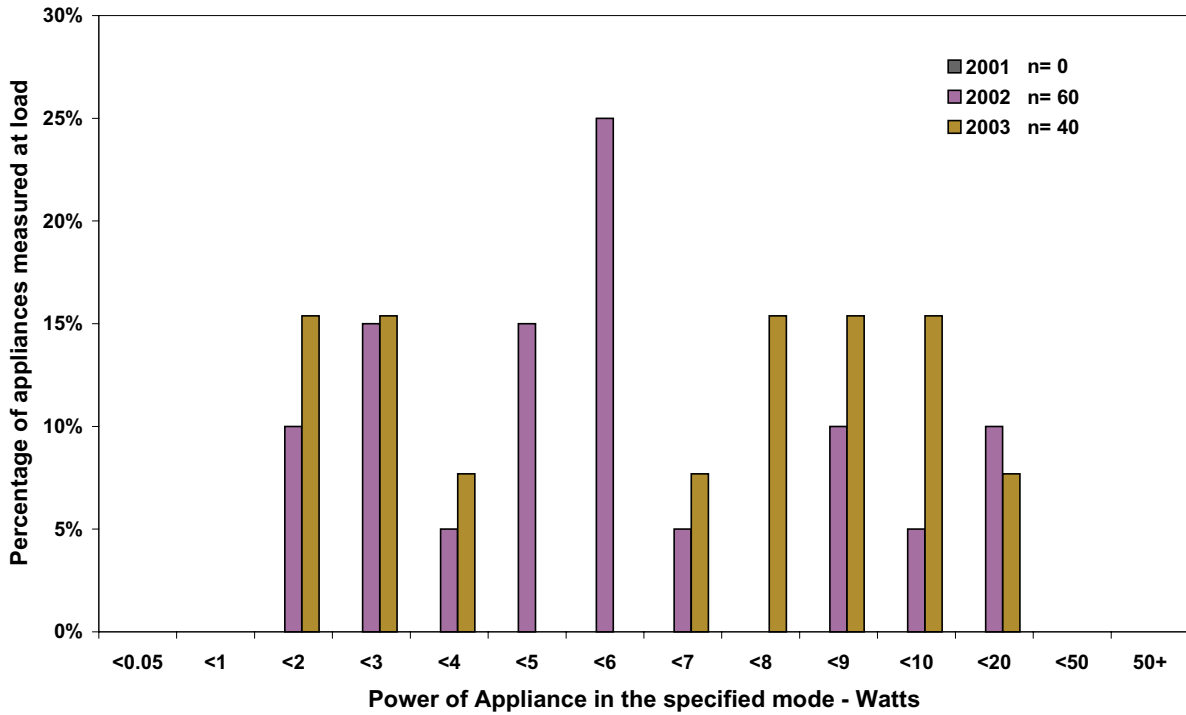
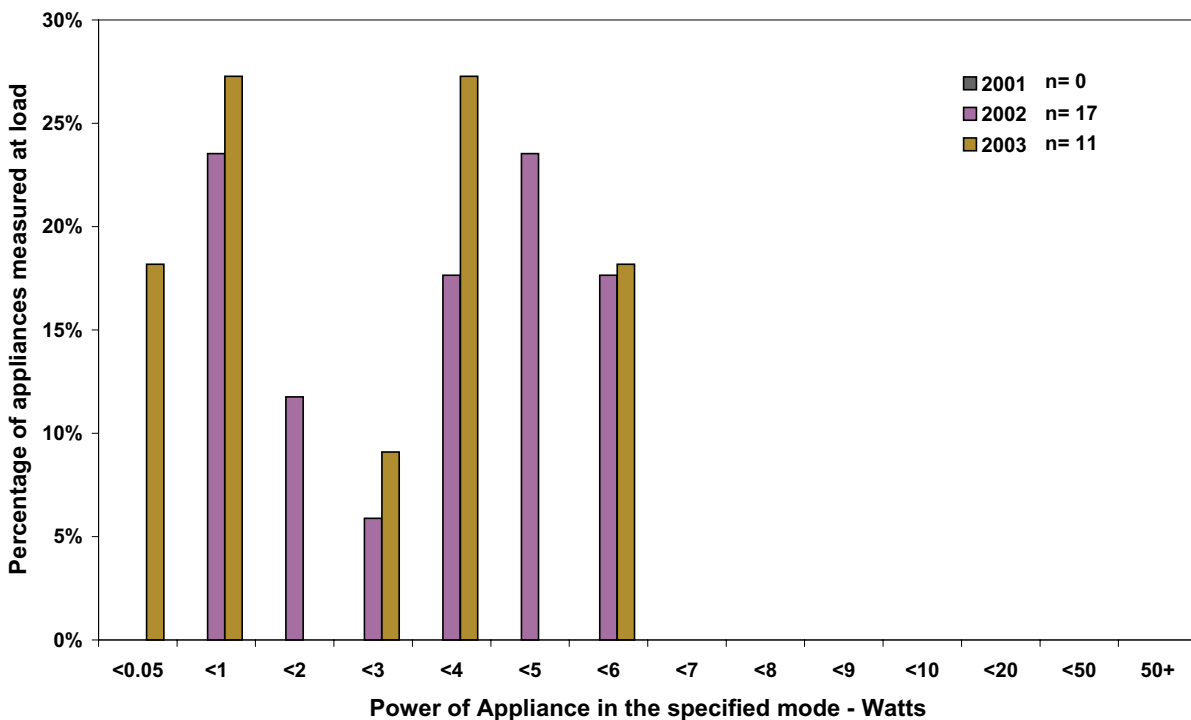


Figure 12 – Power measurements for inkjet printers: off mode



Printers – Lasers

Only 2 laser printers were tested during the 2003 survey and neither of these displayed ENERGY STAR labels. These printers were tested in passive standby and in off mode. The average power consumption in passive standby mode was 3.9W with a maximum of 4.6W and a minimum of 3.3W. In off mode both laser printers recorded zero consumption, as was the case in 2002.

Table 26 – A summary of laser printer results - 2003

Appliance: Printer - Laser				
Mode	No. of Measurements	Average Power (W)	Power Max	Power Min
In Use	0	NA	-	-
Active	0	NA	-	-
Passive	2	3.9	4.6	3.3
Off	2	0.0	0.0	0.0
Total No. of Units	2			

The trend in off mode power consumption appears to be stable with both units recording no consumption. Any other comparisons would be unwise given the small sample sizes (5 in 2002 & 2 in 2003).

Trends in standby are shown in Table 27.

Table 27 – Trends in standby for laser printers

Mode	Power (W) 2001	Power (W) 2002	Power (W) 2003
Passive	NA	6.1	3.9

Other Computer Peripherals

Unlike previous surveys, scanners and computer speakers were not measured in the 2003 survey. In the case of scanners the retail outlets displayed these items without power cords attached for security reasons. For most products this problem can be overcome with a universal power cord, however, with Scanners it was found that cords differed not only between brands but also between models. Of the small number of computer speakers unpackaged most sourced power directly from the PC unit. As such no speakers were measured.



HOME ENTERTAINMENT EQUIPMENT

Televisions

This category covers standard cathode ray tube models for UHF and VHF reception and excludes those models with LCD, plasma or rear projection screens as well as those with in built VCRs (these are separate categories). While all models had remote control operation, it was not possible to access this for all models. The televisions ranged in size from 34cm to 82cm, with the average size on display being 59cm. All of the units tested were colour sets. Of the 72 televisions measured in total, only 3 displayed an ENERGY STAR label. Of these three, two complied with the criteria required to display the label (i.e. consumption was less than 3W). The remaining unit did not have a remote control available and so could not be tested in passive standby to determine if it met the ENERGY STAR testing criteria.

Televisions were tested in 3 modes: in-use, passive standby and off. Two units could not be measured in use as the remote could not be located and it had been left in passive standby mode. The average power consumption for a television in use was 79W with the maximum being 162W and the minimum being 40.5W. The average crest factor (2.69) and average power factor (0.67) were both moderate.

56 televisions were measured in passive standby mode; 16 units could not be measured due to remote controls not being available and a

manual standby function not present. In this mode the average power consumption was 5.9W with a maximum of 35.4W and a minimum of 0.5W. Low average power factor was recorded at 0.48 with a moderate average crest factor of 3.22.

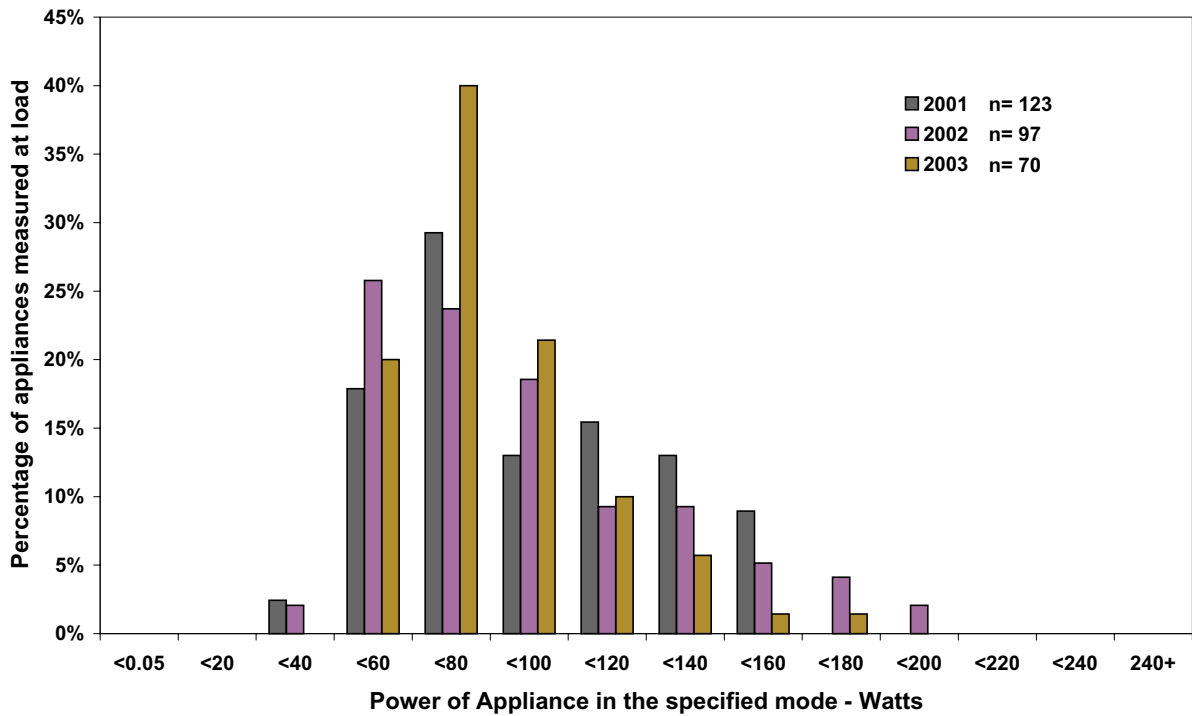
All televisions could be measured in off mode with the average consumption recorded at 0.0W. The highest reading was 0.1W. Both average power factor and average crest factor were low at 0.0 and 2.59 respectively. Table 28 summarises these results.

Figure 13 shows the distribution of power measurements for televisions when in use for the years 2001, 2002 and 2003. The chart shows that the majority of televisions use between 50W and 100W although 2003 has seen an increase in those using less than 50W in use. Average in use power consumption fell significantly from 2002 to 2003 from 88.3W to 79.1W. It should be noted that the average size of TVs measured in 2003 was lower than in 2002 (59cm compared to 62cm) and in 2002, a greater number of televisions were measured with a screen size of more than 80cm (15 units compared to 5 units in 2003). Therefore, it is possible that the larger sized units (with a corresponding higher energy consumption) measured in 2002 increased the average in that year. As such, these results should be treated with careful optimism and future monitoring will reveal if in use consumption is actually trending downwards.

Table 28 – A summary of television results - 2003

Appliance: TV - standard						
Mode	No. of Measurements	Average Power (W)	Average Power Factor	Average Crest Factor	Power Max	Power Min
In Use	70	79.1	0.67	2.69	162.0	40.5
Active	0	NA	NA	NA	-	-
Passive	56	5.9	0.48	3.22	35.4	0.5
Off	72	0.0	0.31	2.59	0.1	0.0
Total No. of Units	72					

Figure 13 – Power measurements for televisions: in-use mode



Note: This figure has non standard power bins.

Trends in standby are shown in Table 29.

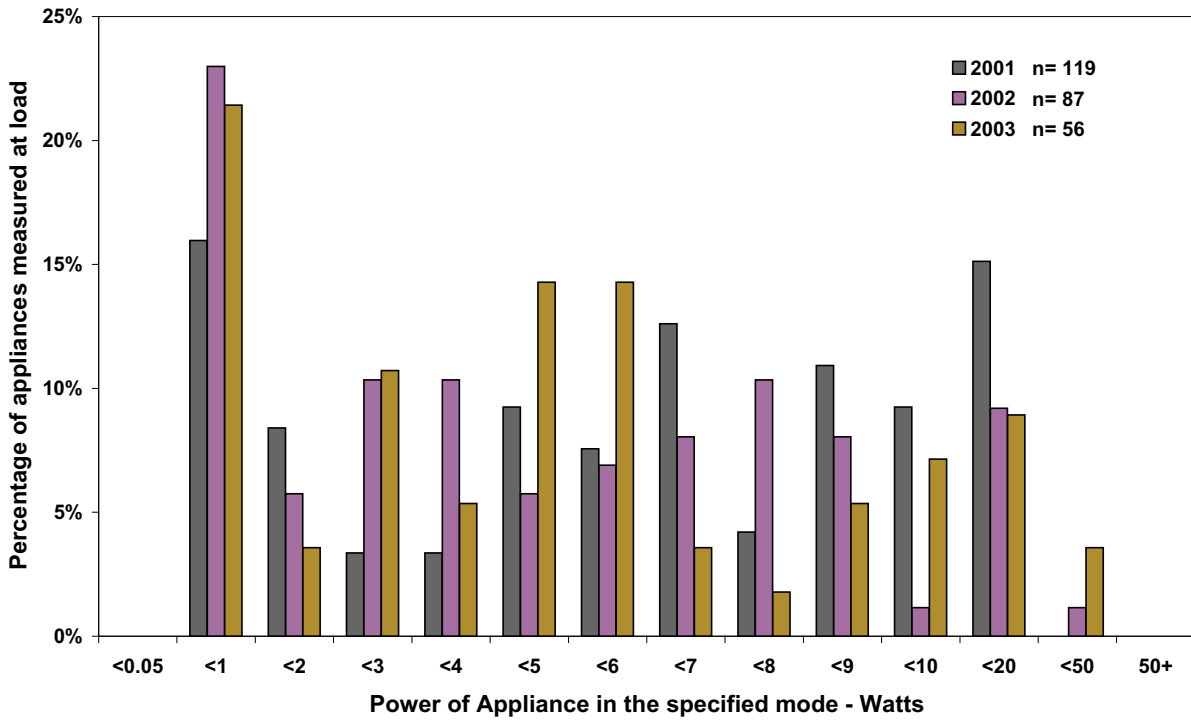
Table 29 – Trends in standby for televisions – standard

Mode	Power (W) 2001	Power (W) 2002	Power (W) 2003
In Use	88.7	88.4	79.1
Passive	6.0	5.1	5.9
Off	0.0	0.0	0.0



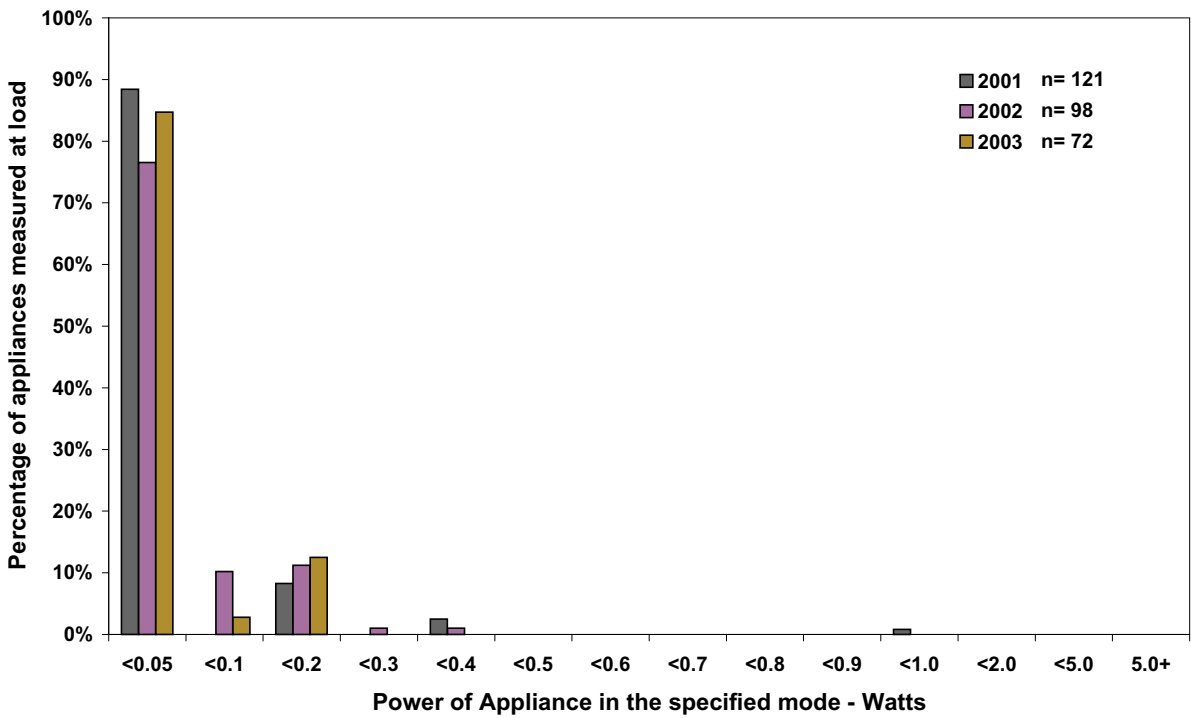
Passive standby mode in 2003, as in previous years, showed readings that were widely distributed. Around 20% of televisions consumed less than 1W in passive standby which is a slight improvement since 2001. However, as Figure 14 shows, there are still a high proportion of units with a passive standby of between 4W and 6W (28%). Average consumption in passive standby in 2001 was 6.0W and this fell (although not significantly) to 5.1W in 2002. In 2003, the average was 5.9W with no statistically significant improvement noted from 2001.

Figure 14 – Power measurements for televisions: passive standby mode



In off mode all televisions consume less than 1W with zero consumption recorded for the vast majority. This is illustrated in Figure 15.

Figure 15 – Power measurements for televisions: off mode



Note: This figure has non standard power bins.



LCD Televisions

In 2003 only 1 LCD (liquid crystal display) television was measured and only 2 were measured in the 2002 store survey. Apart from the limited number of units measured, the 2002 and 2003 results cannot be compared as in 2003, the screen size and corresponding in use energy consumption was vastly smaller compared to 2002. In 2002 one model had a 100cm screen while the other was 109cm. In 2003, the screen size for the unit measured was 50cm.

The units measured in the 2002 store survey registered 168W and 155W in use, compared to 54.7W for the unit in 2003. The units measured in 2002 showed that there was a large difference in passive standby with the maximum being 8.6W and the minimum being 1.1W. The unit measured in 2003, registered 1.2W in passive standby. Both units in 2002 consumed 0.1W in off mode while in 2003 the unit measured 0.6W in off mode.

Trends in standby are shown in Table 30.

Table 30 – Trends in standby for televisions – LCD

Mode	Power (W) 2001	Power (W) 2002	Power (W) 2003
In Use	NA	161.5	54.7
Passive	NA	4.9	1.2
Off	NA	0.1	0.7

Projection Televisions

Projection televisions are either a front or rear projection type. The models measured in the survey mostly had 109cm screens however they ranged upward to 135cm. Of the 16 units measured in total, 3 displayed an ENERGY STAR label. All complied with the specifications required to display the label (passive standby consumption was <3W).

Projection televisions were measured when in use, passive standby and off modes. When in use the average power consumption was 174.7W with a maximum of 226W and a minimum of 113W. The average power factor and average crest factor were both moderate at 0.71 and 2.33 respectively. When in passive standby the range of consumption extended from 0.2W to 10.1W producing an average of 2.3W. The average power factor (0.24) and average crest factor (2.33) were both low. In off mode the average power consumption was 0.1W with a maximum of 0.1W and a minimum of 0.1W. These results are summarised in Table 32.

As presented in Figure 16 most projection televisions consume less than 2W when in passive standby and this is consistent across all years. A small number of units consume between 10W and 20W.

All projection televisions consume less than 1W when in off mode.

Trends in standby are shown in Table 31.

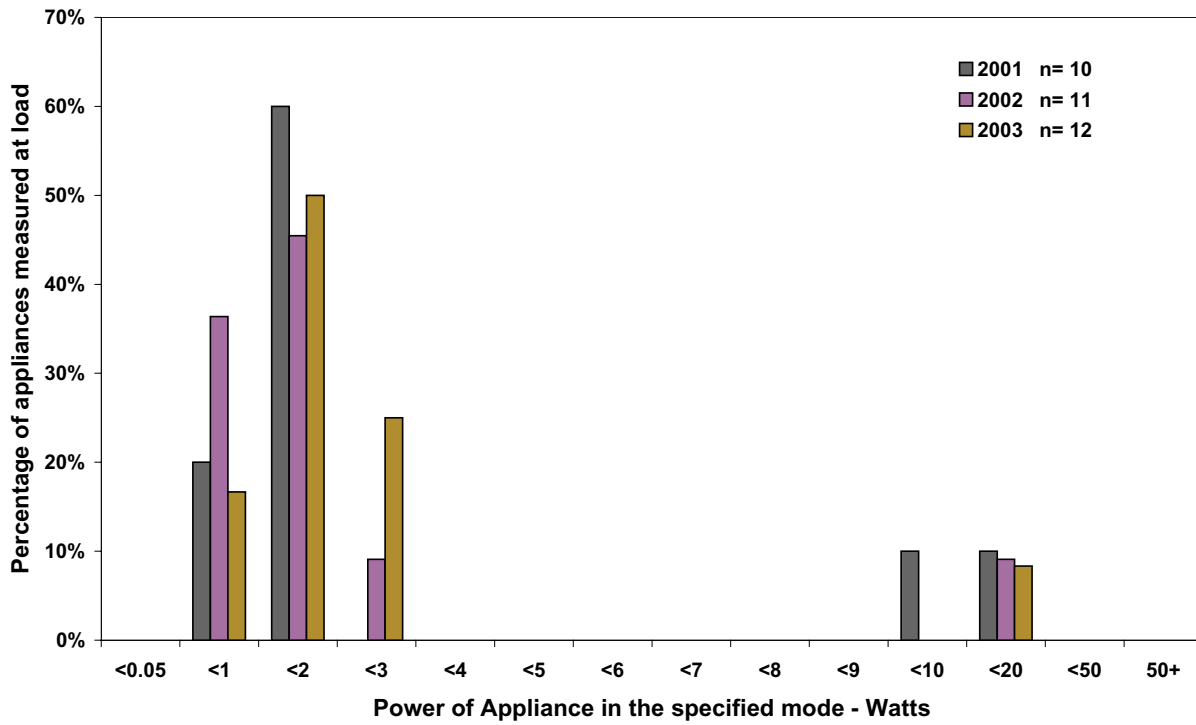
Table 31 – Trends in standby for televisions – Projection

Mode	Power (W) 2001	Power (W) 2002	Power (W) 2003
In Use	175.6	153.9	174.7
Passive	3.0	2.0	2.3
Off	0.0	0.1	0.1

Table 32 – A summary of projection TV results - 2003

Appliance: TV - projection						
Mode	No. of Measurements	Average Power (W)	Average Power Factor	Average Crest Factor	Power Max	Power Min
In Use	16	174.7	0.71	2.33	226.0	113.3
Passive	12	2.3	0.24	2.33	10.1	0.2
Off	15	0.1	0.01	2.01	0.1	0.1
Total No. of Units		16				

Figure 16 – Power measurements for projection televisions: passive standby mode



Plasma Televisions

This year 13 plasma televisions were measured. Plasma televisions are becoming more widely available despite their very high cost (the most expensive one measured was \$22,999). They provide high definition colour and picture quality and because they are only about 10cm deep, they can be wall mounted or even placed on a table for viewing. The plasma televisions in the survey were measured in use, in passive standby and in off. One of the plasma televisions displayed an ENERGY STAR label and the passive consumption reading complied with the ENERGY STAR requirements (<3W).

In use, plasma televisions were found to use considerable power in use. The maximum power usage was 444W in use for one unit while the minimum measurement was still a very high 194.5W. The average in use consumption was 292.4W. The maximum passive standby mode was 5.2W and the minimum at 0.7W. Three units did not have an on/off switch so only 9 units could be measured in off mode. The average consumption for off was 0.7W with the maximum at 2.5W and minimum at 0.0W. Table 33 presents the results for the plasma televisions measured.

Table 33 – A summary of plasma TV results - 2003

Appliance:		TV - Plasma				
Mode	No. of Measurements	Average Power (W)	Average Power Factor	Average Crest Factor	Power Max	Power Min
In Use	10	292.4	0.94	1.74	444.0	194.5
Passive	12	2.4	0.09	1.69	5.2	0.7
Off	9	0.7	0.06	1.74	2.5	0.0
Total No. of Units	13					

Trends in standby are shown in Table 34.

Table 34 – Trends in standby for televisions – Plasma

Mode	Power (W) 2001	Power (W) 2002	Power (W) 2003
In Use	302.8	NA	292.4
Passive	NA	NA	2.4
Off	NA	NA	0.7

Note: Only one unit was measured in 2001.

Figure 17 below shows the distribution of measurements for plasma televisions in passive standby. Most units registered less than 3W.

Figure 17 – Power measurements for plasma televisions: passive standby mode

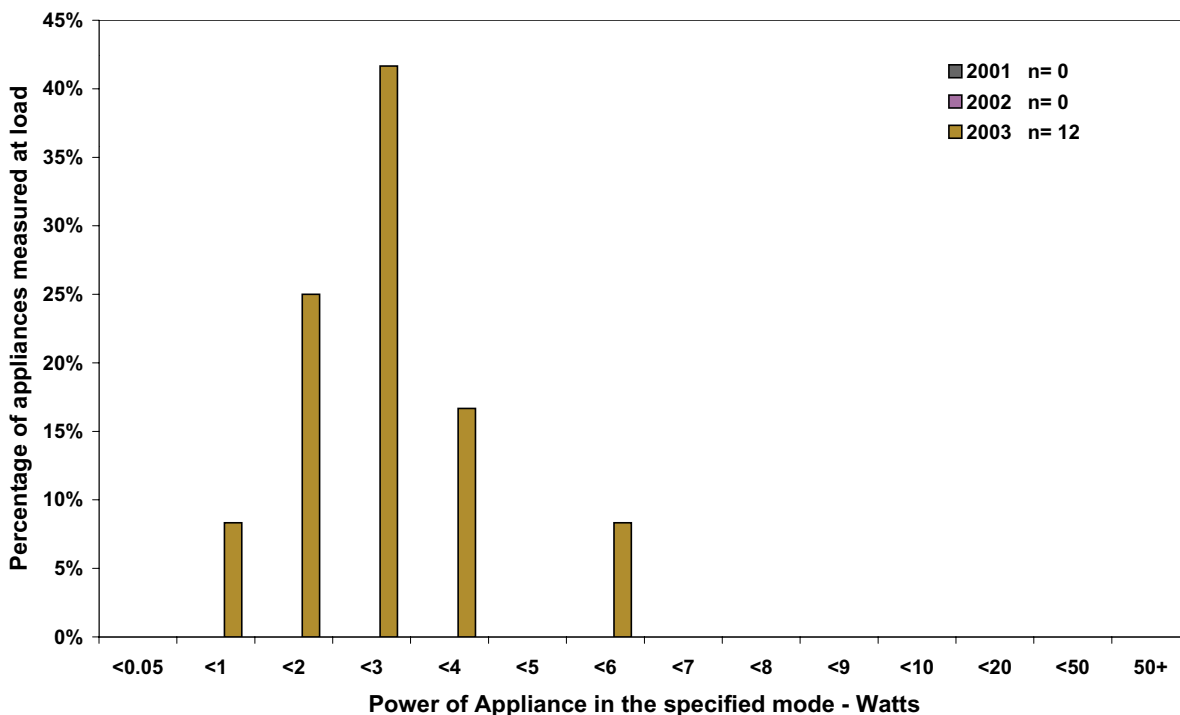
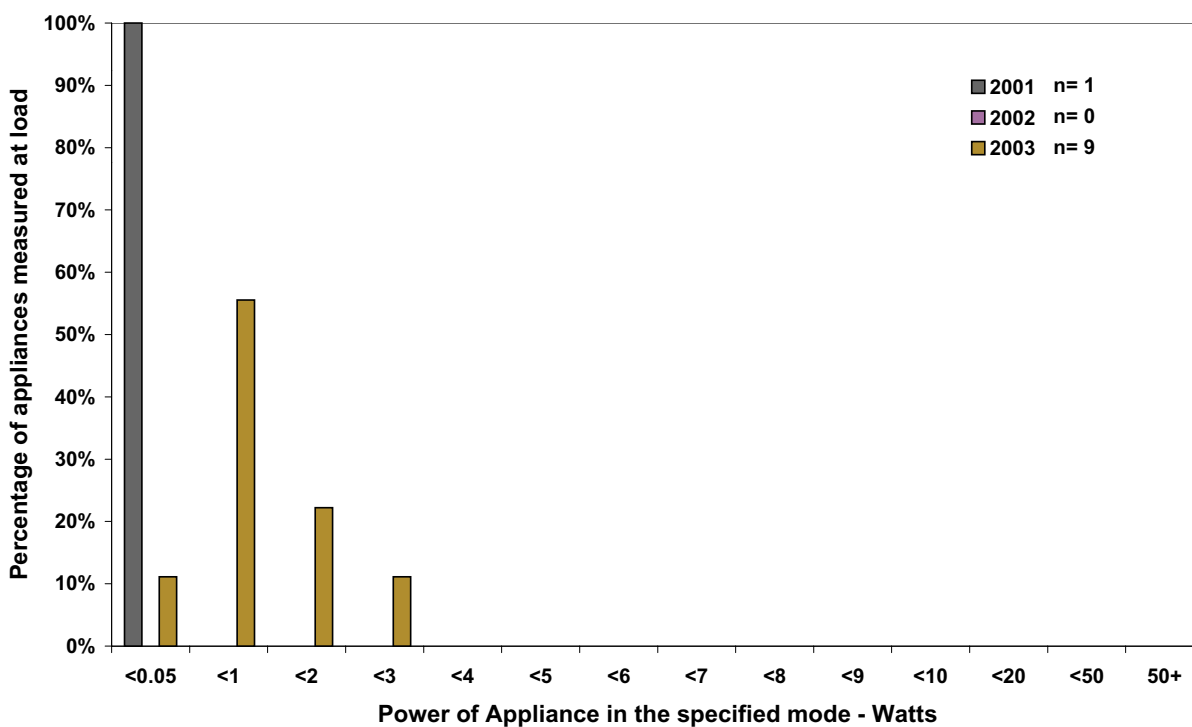


Figure 18 shows the distribution of readings for plasma televisions in off. The graph also shows that one plasma TV was measured in the 2001 store survey and that it registered less than 0.05W.

Figure 18 – Power measurements for plasma televisions: off mode



TV/VCR

A TV/VCR is a standard television with a built-in video recorder. Only 2 models were measured in the 2002 survey and a further 2 models were measured in the 2003 survey. None of the units measured in 2003 displayed an ENERGY STAR label. Seven such units were measured in 2001. Sample sizes are too small for comparison between years but passive standby consumption appears to be quite high for these units with an average of 7.8W in 2003, 8.5 in 2002 and 7.4 in 2001.

Monitoring of TV/VCRs in future years is not likely due to the increasing popularity of DVD players and other home theatre equipment. TV/VCRs are not considered a priority in standby policy development.

Trends in standby are shown in Table 35.

Table 35 – Trends in standby for TV/VCR

Mode	Power (W) 2001	Power (W) 2002	Power (W) 2003
In Use	59.3	68.6	50.8
Passive	7.4	8.5	7.8
Off	0.2	0.2	0.0

VCRs

VCRs were still measured in this year's survey, although they are becoming superseded by DVD players which offer superior sound and picture quality and convenience in user operation. Of the 25 VCRs measured in total, 8 displayed an ENERGY STAR label. All complied with the ENERGY STAR criteria (passive standby consumption less than 4W). All VCRs in the study had remote control operation. None of the models could be turned off and all had some type of clock display. The VCRs were measured in active standby that is, on but not playing and in passive standby, that is, ready for remote operation and still displaying the clock.

A total of 25 units were measured Table 36 summarises the results.

Figure 19 shows the distribution of power consumption for VCRs in active standby mode. All three years of data is shown in the graph. The results show an improvement in active standby power consumption, although no VCRs measured in 2003 consumed less than 5W in this mode. Average active standby results show that consumption is trending downwards with average active standby at 10.9W in 2001, 9.0W in 2002 and 8.0W in 2003.

Care is need in the interpretation of this result, as most VCRs will go to "sleep" when left in active standby mode without playing a tape for some period (typically 20 minutes). For practical reasons it was not possible to make this measurement during the in store survey (a delay of 20 minutes after the power is connected to make a power measurement). Experience indicates that a VCR which is left on but allowed to go to "sleep" will consume less than active standby but more than passive standby (typically sleep mode consumption will be about an average of active and passive standby). This "sleep" mode would be a common mode in normal use in households where the VCR is left "on" after use.



Table 36 – A summary of VCR results - 2003

Appliance: VCR						
Mode	No. of Measurements	Average Power (W)	Average Power Factor	Average Crest Factor	Power Max	Power Min
Active	25	8.0	0.53	3.36	12.0	5.9
Passive	25	3.1	0.41	3.94	4.6	1.4
Off	0	NA	NA	NA	-	-
Total No. of Units	25					

Trends in standby are shown in Table 37.

Table 37 – Trends in standby for VCR

Mode	Power (W) 2001	Power (W) 2002	Power (W) 2003
In Use	14.2	NA	NA
Active	10.9	9.0	8.0
Passive	3.8	3.5	3.1
Off	1.3	NA	NA

No VCRs measured in either 2001, 2002 or 2003 were found to consume less than 1W in passive standby mode. Most models consumed between 2W and 4W with only a few units above this range. These results are presented in Figure 20. As with active standby, average passive standby appears to be trending downwards with the average at 3.8W in 2001, 3.5W in 2002 and 3.1W in 2003. However, no statistically significant differences were noted.

Figure 19 – Power measurements for VCR: active standby mode

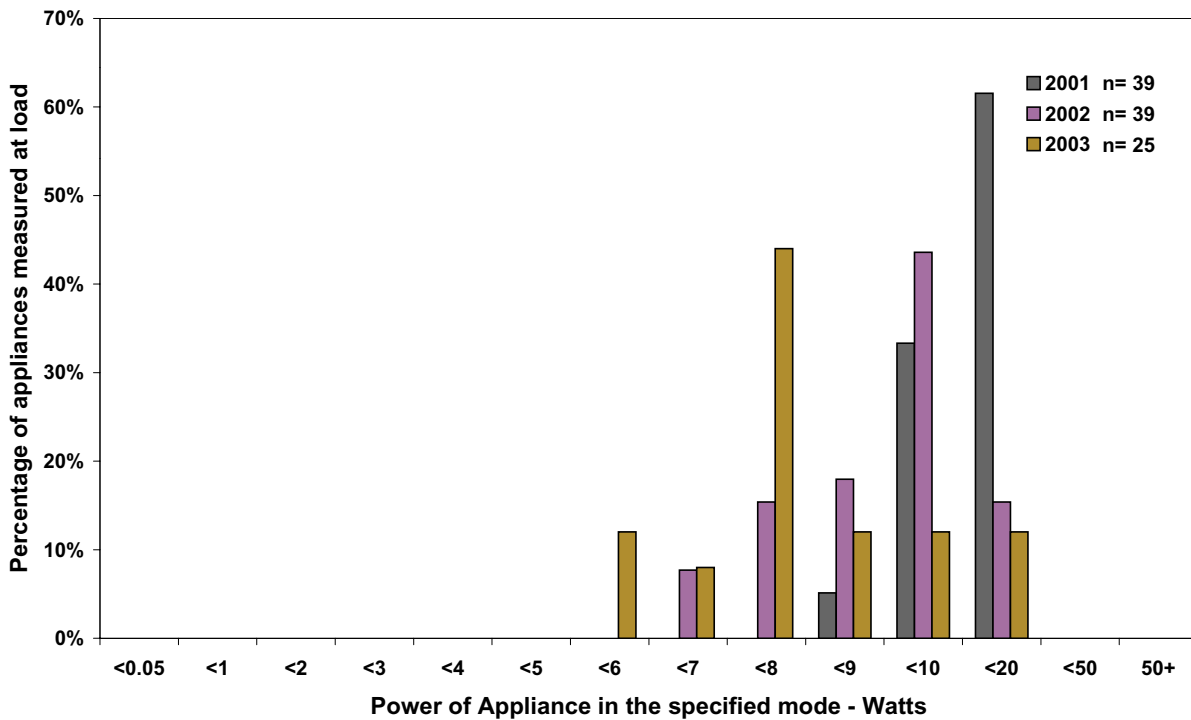
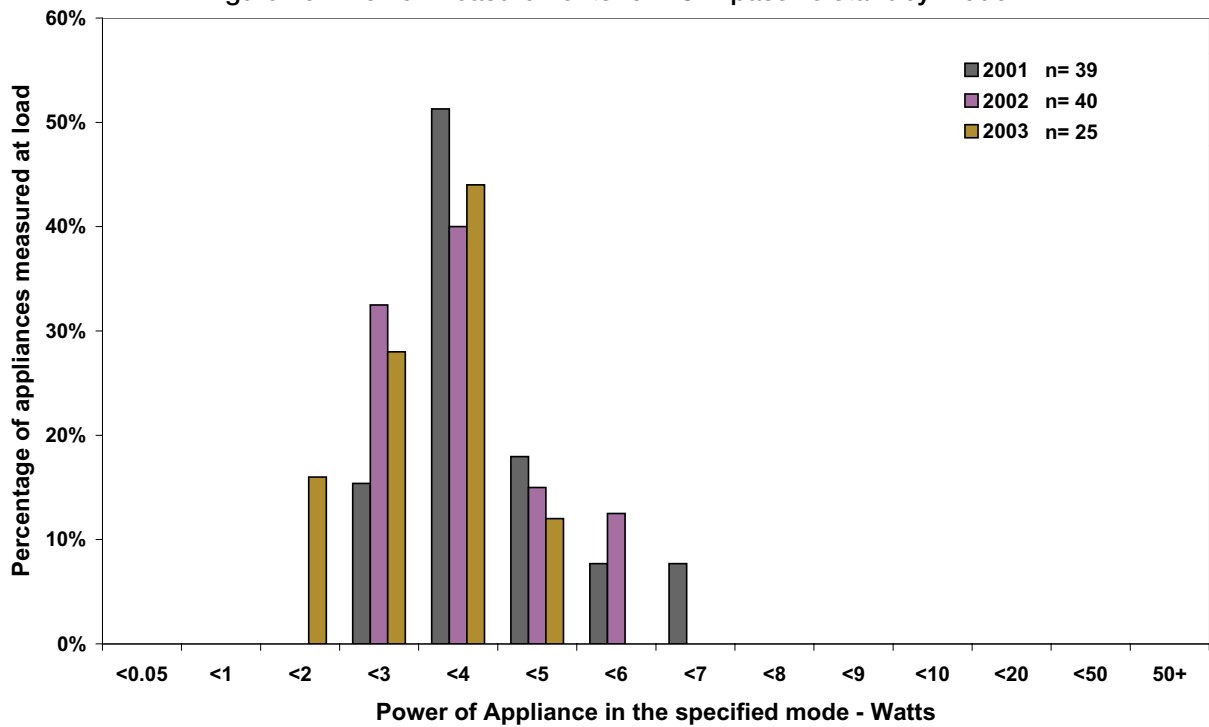


Figure 20 – Power measurements for VCR: passive standby mode



DVD/VCR Combos

DVD/VCR combination units allow you to watch both DVDs and video tapes with the added function of being able to record on video, like a standard VCR. Six DVD/VCR combination units were measured in this year’s survey and none of these displayed an ENERGY STAR label. The units were measured in active standby and passive standby. All units can be operated with a remote and none of the units had an on/off switch. It is the first time that combination units have been included in the store survey.

Table 38 below summarises the results for DVD/VCR combo units. Active standby is quite high for the units measured with an average of 17.3W. The minimum was 15.5W and the maximum 19.0W. The same provisos for active standby as noted for VCRs apply to these units. Passive standby was moderately high with the average at 4.3W and the minimum and maximum at 3.4W and 4.8W respectively. It is hard to imagine that DVD/VCR combination units will be embraced the same way that DVD players currently are in the Australian market place. Their main appeal is that these combination units offer new DVD technology while allowing the consumer to record using

cheap conventional VCR technology. However, as DVD recorders become more competitively priced (and DVD media also becomes cheaper) it is likely that DVD/VCR combos will lose their market advantage. As such, this technology is probably only a moderate priority for standby power policy, but market trends should be monitored.

Table 38 – A summary of DVD/VCR combination unit results

Appliance: DVD & VCR Player				
Mode	No. of Measurements	Average Power (W)	Power Max	Power Min
Active	6	17.3	19.0	15.5
Passive	6	4.3	4.8	3.4
Total No. of Units	6			

Trends in standby are shown in Table 39

Table 39– Trends in standby for DVD & VCR Player

Mode	Power (W) 2001	Power (W) 2002	Power (W) 2003
Active	NA	NA	17.3
Passive	NA	NA	4.3

DVD Players

Digital Video Disk players, more commonly known as DVDs, are gaining increasing popularity in the Australian market place. DVDs deliver superior sound and picture quality and compared to VCRs offer much greater user convenience. DVD players are also able to play CDs and video games, link to the Internet and even record and play home movies. 39 units were tested and of those, 6 displayed an ENERGY STAR label. Of the six, 3 units complied with Phase I criteria (which stipulates that all models in the market place before 31 December 2002 register 3W or less). A further 2 units complied with Phase II criteria (applicable to all units released onto the market after 1 January 2003) which requires units to consume less than or equal to 1W in passive standby. The remote control for one of the units could not be located and as such, this unit could not be measured in passive standby to determine if it complied with ENERGY STAR criteria.

DVDs were measured in 3 modes: active standby (that is, ready to play a disc), passive standby (that is, ready to be activated) and off (where present - that is, powered down but not able to be activated by a remote). Many models do not have an off switch and are always ready for remote activation (passive standby only).

All 39 units measured in 2003 could be tested in active standby with the average consumption being 9.9W. The range varied from a minimum of 6.9W to a maximum of 16.6W. The average power factor of 0.49 and the average crest factor of 3.6 fall into the moderate range. Passive standby could be measured on only 27 units as remote controls were not always

available and because some units do not have a remote function. The average power consumption was found to be 1.7W in passive standby with a minimum of 0.0W and a max of 5.7W. The average power factor was low at 0.39 while the average crest factor was high at 4.60. Approximately one third of DVD players had a power on/off control providing a total of 12 measurements for the off mode. The average power consumption was 0.1W with results ranging from zero to 0.5W. The average power factor was low at 0.2 while the average crest factor was high at 4.40. For a summary of these results see Table 40 below.

DVD players are already showing improvements in active standby power consumption in the short time that they have become available. Figure 21 below shows how power consumption between 10W and 20W has declined since 2001 and how the distribution has shifted into categories less than 10W. In 2001, average active standby was 14.9W, in 2002 it was 13W and in 2003 average active standby was 9.9W. The improvement between 2001 and 2003 is statistically significant providing a strong indication that active standby is trending downwards.

Trends in standby are shown in Table 41.

Table 41– Trends in standby for DVD - Players

Mode	Power (W) 2001	Power (W) 2002	Power (W) 2003
In Use	17.4	NA	NA
Active	14.9	13.0	9.9
Passive	5.8	3.0	1.7
Off	0.8	0.1	0.1



Table 40 – A summary of DVD player results - 2003

Appliance: DVD Player						
Mode	No. of Measurements	Average Power (W)	Average Power Factor	Average Crest Factor	Power Max	Power Min
In Use	0	NA	NA	NA	-	-
Active	39	9.9	0.49	3.60	16.6	6.9
Passive	27	1.7	0.39	4.60	5.7	0.0
Off	12	0.1	0.20	4.40	0.5	0.0
Total No. of Units	39					

Figure 21 – Power measurements for DVD players: active standby mode

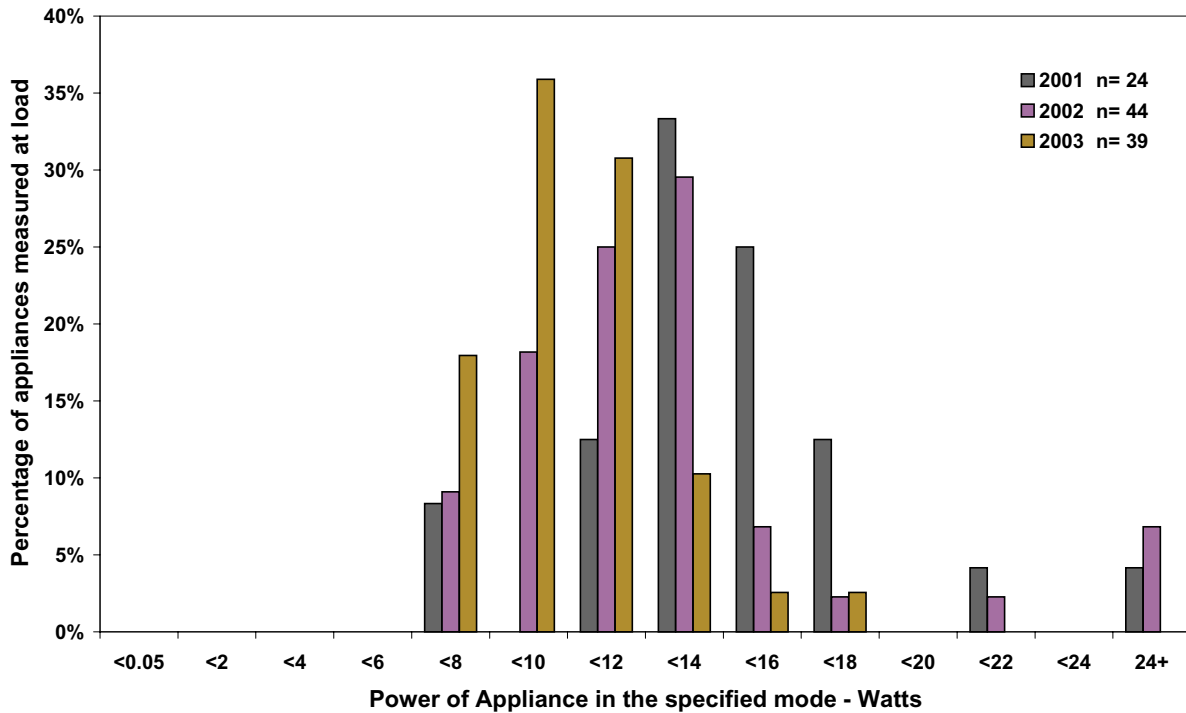


Figure 22 shows that a greater proportion of DVD players consume less than 3W in 2003 compared to previous years. Average power consumption has improved significantly between all years with average passive standby at 5.8W in 2001, 3.0W in 2002 and 1.7W in 2003. This significant improvement is a positive indicator that passive standby consumption is rapidly declining in DVD players.

Only 5 of the 39 units (13%) measured had an on/off switch and generally these units were “budget” priced units that did not have a remote control. A further 7 units were measured in off mode as the remote control for the unit could not be located and so the unit could not be

measured in passive standby. The results show that off mode consumption for DVD players has also improved such that all units measured in 2003 registered less than 1W. Figure 23 illustrates the results.

The intrusive survey in 2000 measured passive and active standby data for 8 DVD players installed in residential houses. Average passive standby mode power for these models was 11.2W while active standby was 13.2W. Given these results and the improvements noted above, a clear downward trend is evident in DVD players in both active and passive standby modes.

Figure 22 – Power measurements for DVD players: passive standby mode

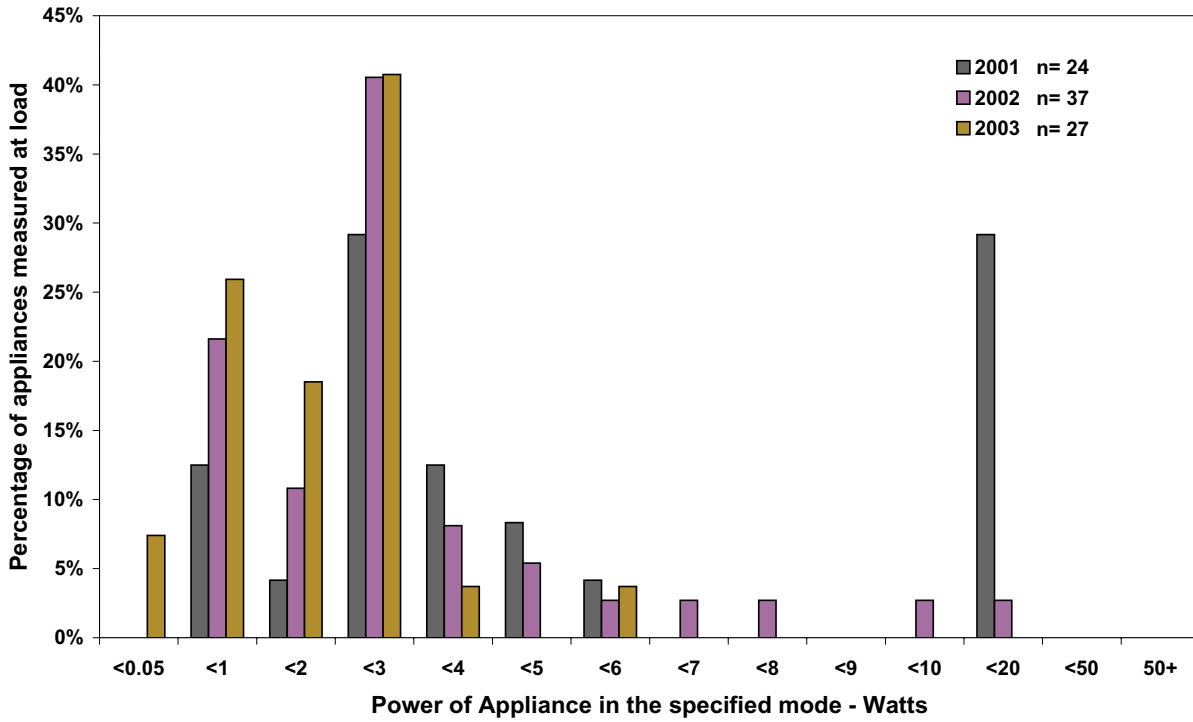
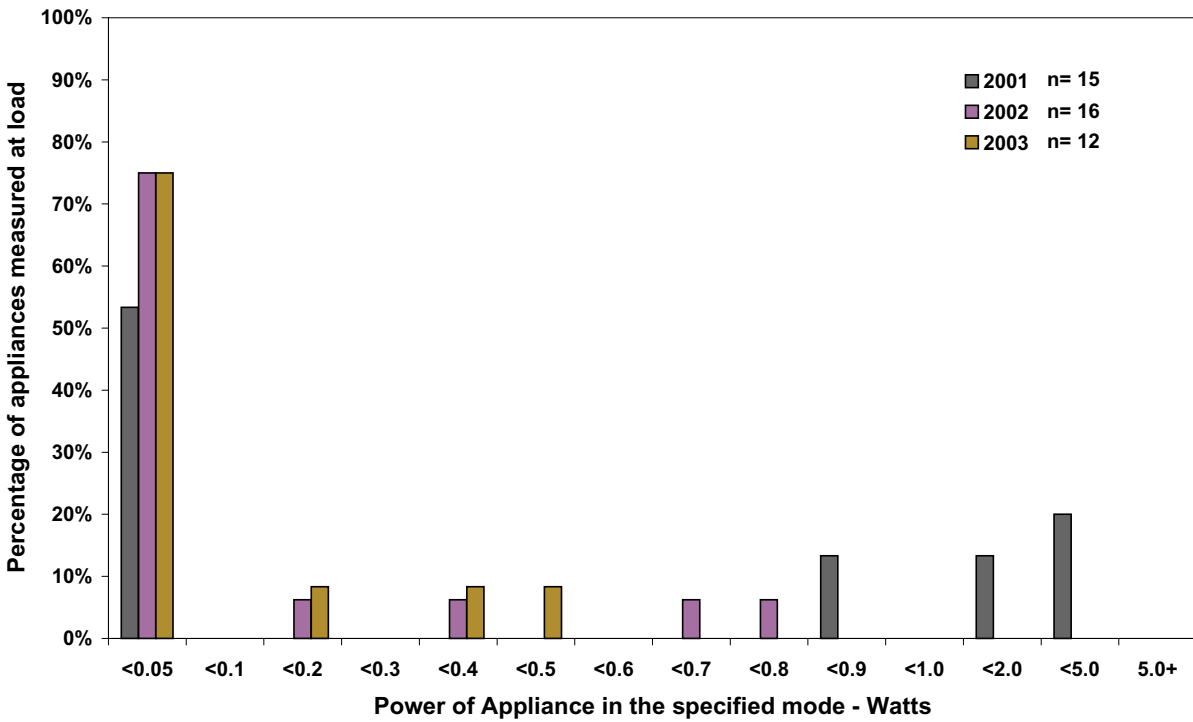


Figure 23 – Power measurements for DVD players: off mode



Note: This figure has non standard power bins.



DVD Recorders

DVD Recorders are a newly emerging technology that allows the user to play DVDs as well as record from television onto a DVD. DVD recorders offer varying levels of sophistication with newer models incorporating a hard disk for recording. Basic functions vary from unit to unit but essentially they are same as a VCR. DVD recorders are still quite expensive to buy but the price of these units are decreasing rapidly. Blank DVD media is still relatively expensive, which will limit their mass appeal in the short term.

Only one DVD recorder was measured in the 2003 survey, the unit was measured in active standby and passive standby. The unit did not have an ENERGY STAR label. In active standby the unit measured 25.1W and in passive standby 9.1W. It is expected that as DVD recorders decrease in price they will increase their market penetration. Standby in DVD recorders will be monitored closely in forthcoming store surveys.

Integrated Stereos

Integrated stereos are single units that perform more than one function such as CD player, tuner, tape deck, amplifier etc. Most units had remote control as well as manual operation. Variants included CD capacity, presence of a tape deck, and digital displays. The survey measured 35 of these appliances and of those 6 displayed an ENERGY STAR label. Interestingly, of the 6 units, only 2 complied with ENERGY STAR criteria stipulated in Phase I (where passive standby consumption for appliances released on the market before 31 December 2002 is less than or equal to 2W). **The remaining four units exceeded the 2W limit significantly.**

Integrated stereos were measured in 2 modes: active standby, that is, ready to play a disc and passive standby, that is, ready to be activated. Only a very small number of integrated stereos (one measured in this survey) had an on/off function. However, in previous

years a greater number of units had an on/off function. In active mode there was a large variation in power consumption with an average of 17.4W and a maximum of 47.8W and a minimum of 6.1W. Only 32 stereos could be measured in passive mode as the remaining models were demonstration units that always operated in active standby. The average power consumption for passive mode was 4.1W with a maximum of 25.2W and a minimum of 0.3W. Off mode was only available on one unit resulting in an average power of 1.6W. These results are summarised in Table 42.

Table 42 – A summary of integrated stereo results - 2003

Appliance: Stereo - Integrated				
Mode	No. of Measurements	Average Power (W)	Power Max	Power Min
In Use	0	NA	-	-
Active	35	17.4	47.8	6.1
Passive	32	4.1	25.2	0.3
Off	1	1.6	1.6	1.6
Total No. of Units	35			

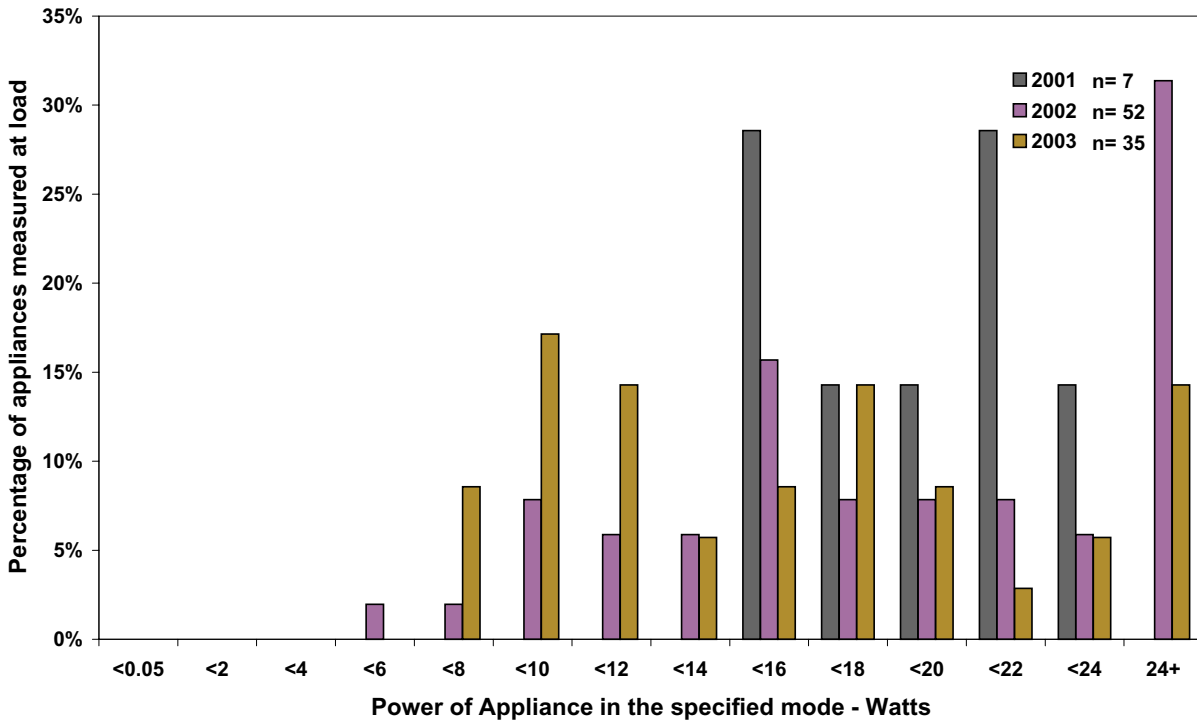
Figure 24 indicates that a high proportion of integrated stereos are consume more than 10W in active standby. Based on average consumption, there has been no significant improvement from 2001 to 2003. In 2001 average active standby was 19.1W, in 2002 it was 20.1W and 2003 average active standby was 17.4W.

Trends in standby are shown in Table 43.

Table 43 – Trends in standby for integrated stereo

Mode	Power (W) 2001	Power (W) 2002	Power (W) 2003
Active	19.1	20.1	17.4
Passive	9.4	7.8	4.1

Figure 24 – Power measurements for integrated stereos: active standby mode

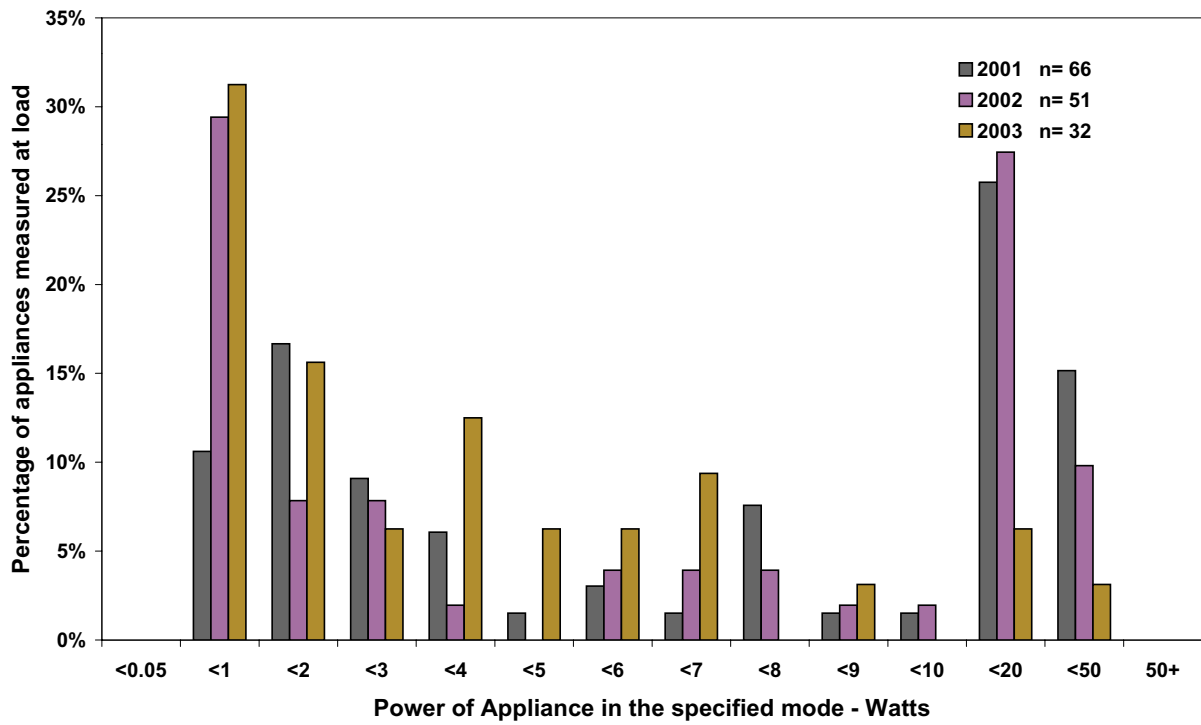


Note: This figure has non standard power bins.

Figure 25 shows that for passive standby, some improvement can be seen in the distribution of measurements over time. A much smaller proportion of units are registering passive standby of more than 10W in 2003 compared with previous years. Nearly one third of units are now achieving passive standby readings of less than 1W. Based on average consumption there has been a statistically significant improvement (i.e. decrease) in passive standby consumption from 2002 to 2003. In 2001 the average was 9.3W, in 2002, 7.8W and in 2003 average passive standby was 4.1W. Further monitoring in forthcoming years will reveal if there is a positive trend emerging although at this early stage the results are very promising.



Figure 25 – Power measurements for integrated stereos: passive standby mode



Portable Stereos

Portable stereos can be operated using mains power or batteries. They are mobile single units that can perform more than one function such as CD player, tuner, tape deck, etc. The survey measured 38 of these appliances and none displayed an ENERGY STAR label. Some units had remote control as well as manual operation. Variants included CD capacity (multi-disk), presence of a tape deck, and digital displays. None of the products tested had an off mode.

These appliances were measured in active and passive standby. In active mode the average power was 5.4W with maximum power measured at 15.4W and minimum at 2.1W. Average power consumption in passive mode was 2.0W and the maximum power was 6.5W with a minimum of 1.0W. Table 44 presents these results.

Table 44 – A summary of portable stereo results - 2003

Appliance:		Stereo - Portable			
Mode	No. of Measurements	Average Power (W)	Power Max	Power Min	
Active	38	5.4	15.4	2.1	
Passive	38	2.0	6.5	1.0	
Total No. of Units	38				

Figure 24 shows the distribution of measurements for portable stereos in active standby. The graph shows that there has been little change in the distribution compared to 2002. The average active standby measurements show that there has been no improvement in active standby with an average of 5.4W in 2003 and 5.2W in 2002. Only one unit was measured in active standby in the 2001 store survey.

Trends in standby are shown in Table 45

Table 45 – Trends in standby for portable stereo

Mode	Power (W) 2001	Power (W) 2002	Power (W) 2003
Active	13.4	5.2	5.4
Passive	2.8	1.8	2.0

Figure 27 shows that there has been a slight increase in the proportion of units registering a passive standby of less than 2W compared to 2001. Overall however, average passive standby shows that there has been no improvement. In 2001 average passive standby was 2.8W, in 2002 it was 1.8W and in 2003 2.0W, which can be regarded as fairly stable.



Figure 26 – Power measurements for portable stereos: active standby mode

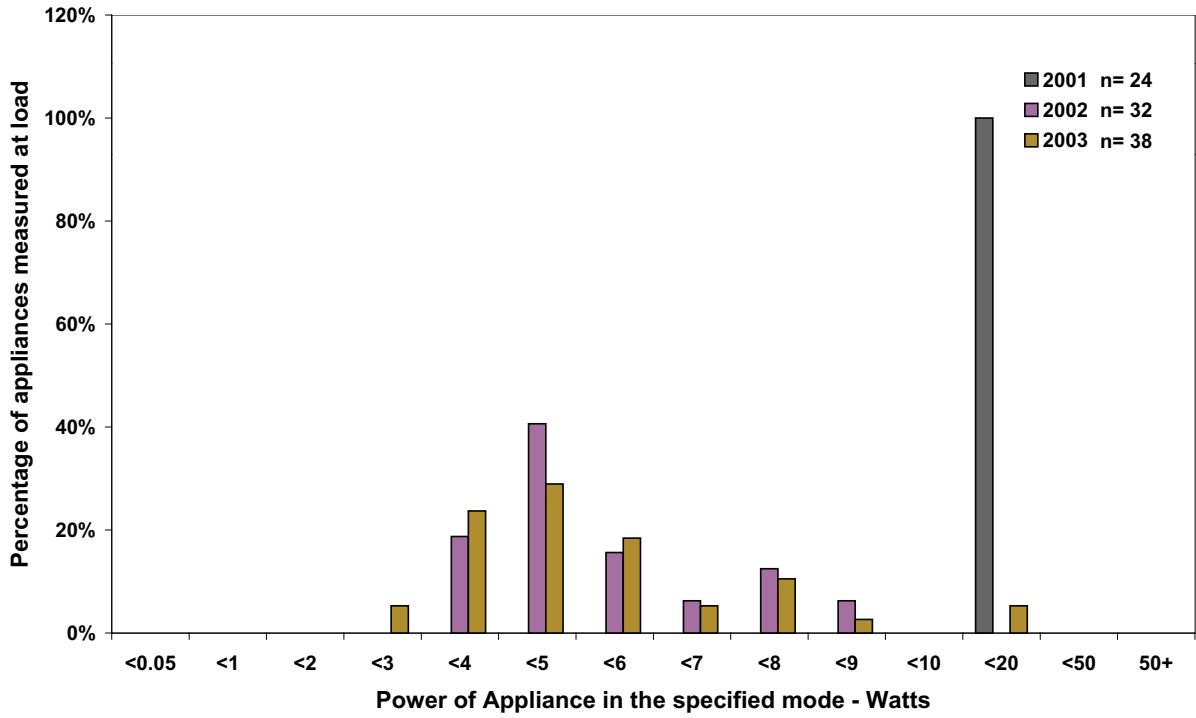
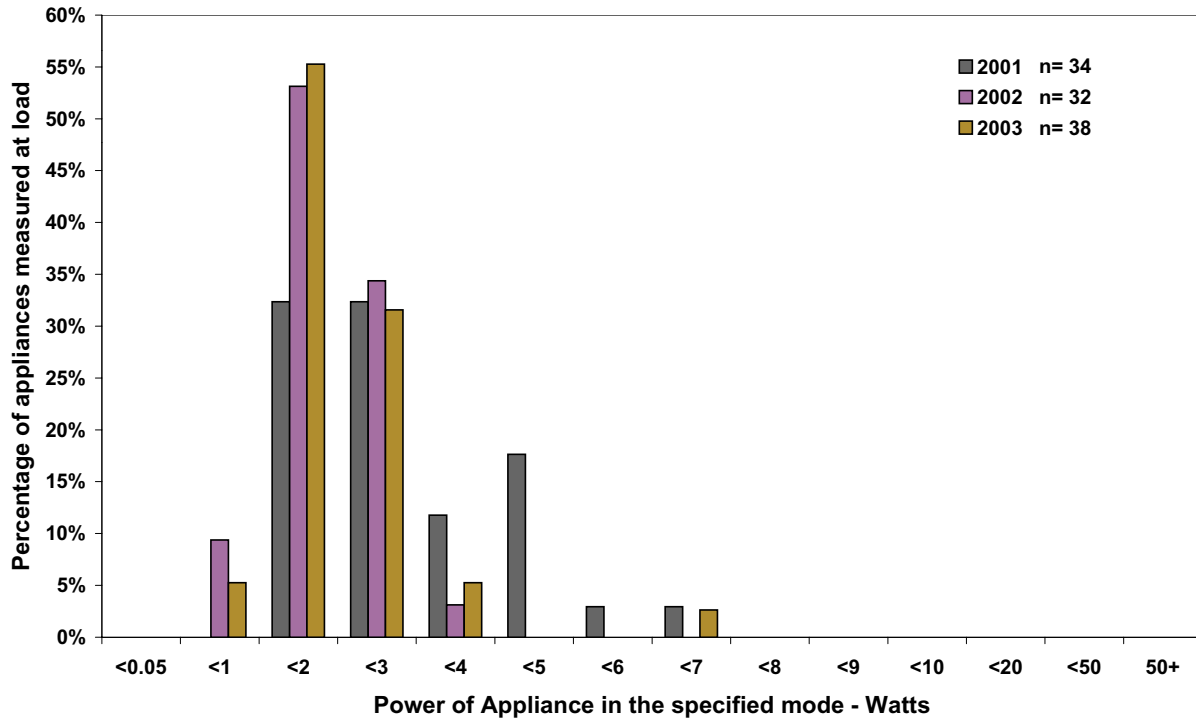


Figure 27 – Power measurements for portable stereos: passive standby mode



Separate Component Stereo Equipment

Previous store surveys conducted in 2001 and 2002 collected data on separate stereo components such as tuners, tape decks, CD players, receivers and amplifiers. The advent of “Home Theatre Systems” and DVD player technology has rendered separate stereo components less relevant. Such equipment may possibly be found at Hi-Fi specialist stores but only a limited number of appliances were offered for sale in the larger electrical retail stores visited in this year’s survey (2 tape decks, 1 amplifier and 4 turntables and these products were not measured in the survey).

Home Theatre Systems – AV Receivers

Home theatre systems are becoming increasingly popular for their superior sound and picture quality that allow the consumer to almost have a cinema experience from home. Home theatre systems are available for sale as separate components or as sets which include an AV receiver with a DVD player, an amplifier and six speakers including a subwoofer for bass sounds. The 2003 survey included measurements from the following components:

1. AV Receivers or surround sound amplifiers⁴, which consist of a number of output channels suitable for both audio and visual (VCRs and DVDs) equipment. Most of the models tested had inbuilt tuners while the others were purely amplification units. Most of the models had remote operation.

2. AV Receivers with DVD players which are essentially the same as AV Receivers described above, except they include a built in DVD player.
3. Subwoofers, which are large speakers that produce low-frequency (bass) sounds, often with their own power supply.

AV Receivers and AV Receivers with DVD players were all measured in use, passive standby and off. Subwoofers were measured in active standby and off. There were no AV receivers measured with an ENERGY STAR label, however one AV receiver with a DVD player did display the ENERGY STAR label. Unfortunately, the remote control could not be located for this unit so it could not be tested in passive standby to verify if the unit complied with the ENERGY STAR criteria. Results for each of these three categories are presented below.

Table 46 provides a summary of the results for the 40 AV receivers measured. When in use the average power consumption was 43.9W with a maximum of 94.5W and a minimum of 12.2W. A total of 31 units could be tested in passive standby mode with the average power being 2.0W. The highest consumption in the mode was recorded at 10.6W with the lowest 0.0W. Half of all AV receivers had an off mode with 20 units being tested in this status. The average power consumption was 0.3W with a high of 2.1W and a low of 0.0W (note that this particular value was recorded with a lower accuracy meter).

⁴ In the 2002 store survey, AV receivers were reported as “surround sound systems”. As the technology is new for these products, the market definitions are also changing and establishing themselves. At the time of writing this report “AV receivers” were considered to be the standard name for this product type.



Table 46 – A summary of AV Receiver results - 2003

Appliance: Home Theatre - AV Receiver				
Mode	No. of Measurements	Average Power (W)	Power Max	Power Min
In Use	40	43.9	94.5	12.2
Active	0	NA	-	-
Passive	32	2.0	10.6	0.0
Off	19	0.2	2.1	0.0
Total No. of Units	40			

Figure 28 shows that the distribution of measurements taken in passive standby has changed in that a greater proportion of units are consuming less than 1W in 2003 compared to 2002. There is still much room for improvement for those units consuming more than 5W. Average passive standby measurements show that there has been no improvement in consumption: in 2002 the average was 2.1W and 2003 the average was 2.0W.

Trends in standby are shown in Table 47.

Table 47 – Trends in standby for home theatre – AV receiver

Mode	Power (W) 2001	Power (W) 2002	Power (W) 2003
In Use	NA	48.3	43.9
Passive	NA	2.1	2.0
Off	NA	0.2	0.2

When in off mode the vast majority of AV receivers consume less than 1W with the vast majority having no consumption. This is demonstrated in Figure 29.

AV receivers (or surround sound amplifiers as they were previously named) were not measured during the 2001 in store survey.

Figure 28 – Power measurements for AV receivers: passive standby mode

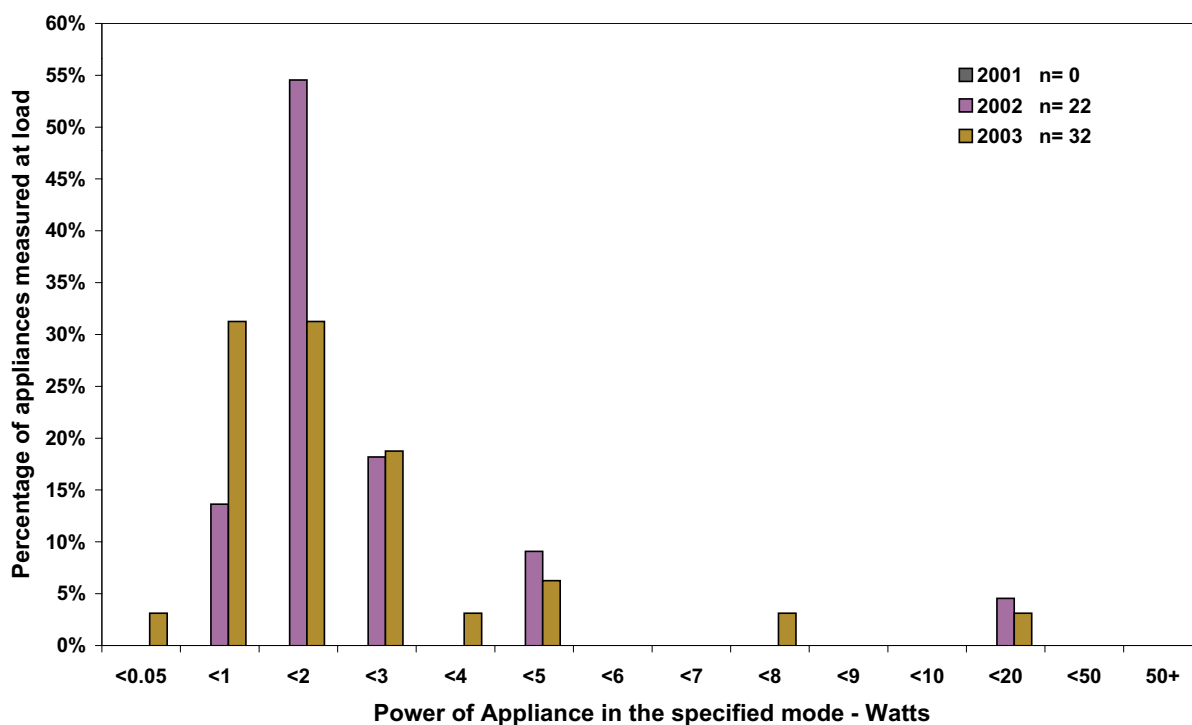
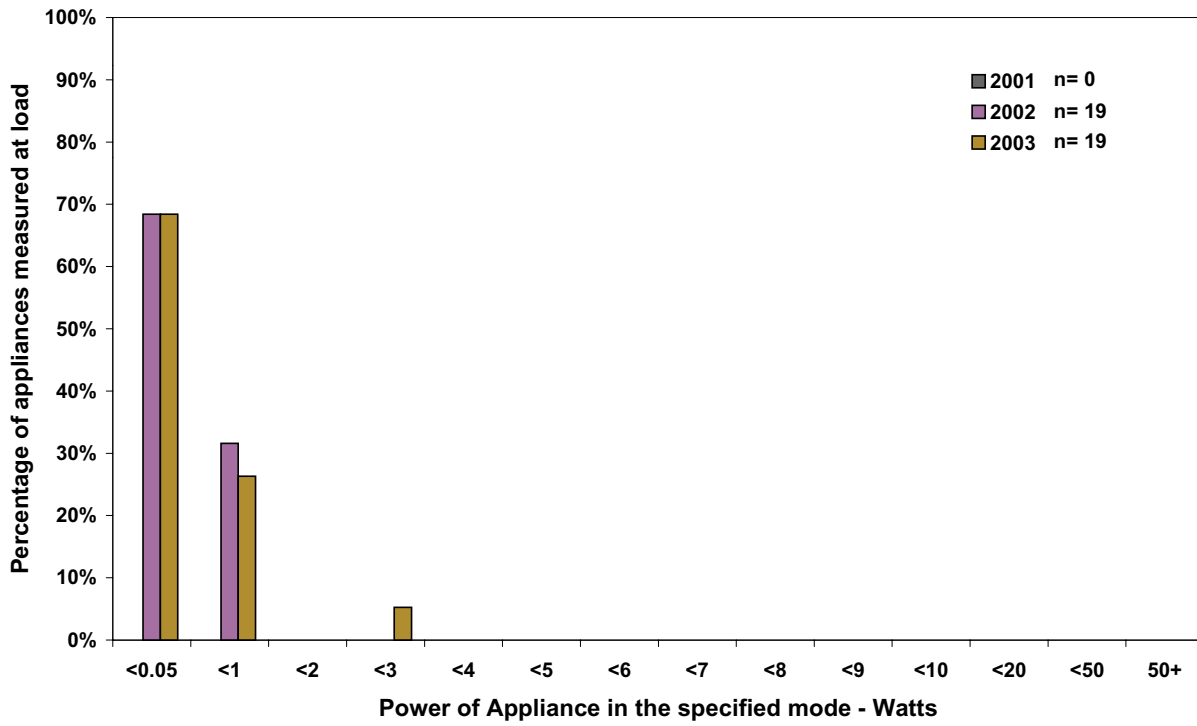


Figure 29 – Power measurements for AV receivers: off mode



Home Theatre – AV Receivers with DVD Players

As mentioned earlier, AV Receivers with DVD players are essentially surround sound amplifiers, which consist of a number of output channels suitable for both audio and visual (VCRs and DVDs) equipment. In this case, the AV receiver has its own built in DVD player.

Sixteen AV Receivers with DVD players were measured in 2003 with all 16 being measured in use. Only 8 units could be measured in passive standby as the remote control could not be located and therefore the units could not be switched into passive standby mode. Nine units were measured in off (those where remotes were not available and one other unit that had an off switch). There was only one unit measured with an on/off capability.

Table 48 provides a summary of the measurements taken. In use power measurements varied significantly from a maximum of 57.5W to a minimum of 12.2W. The average in use consumption was 35.8W. In

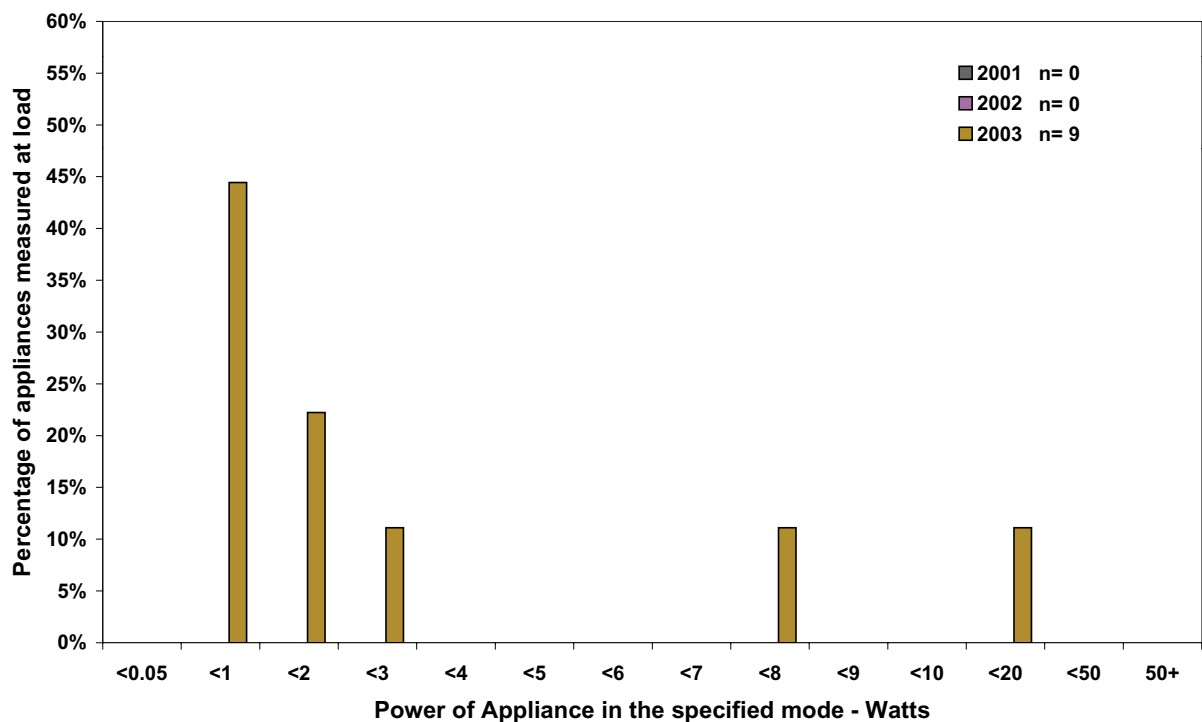
passive standby the average was 3.2W with a maximum of 10.6W and a minimum of 0.6W. In off the average was 0.1W with a maximum of 0.7W and minimum of 0.0W.

Table 48 – A summary of AV Receiver/DVD player results - 2003

Appliance: Home Theatre - AV Receiver/DVD player				
Mode	No. of Measurements	Average Power (W)	Power Max	Power Min
In Use	16	35.8	57.5	12.2
Passive	8	2.9	10.6	0.6
Off	9	0.1	0.2	0.0
Total No. of Units	16			

Figure 30 below shows the distribution of readings for passive standby. The graph shows that while the majority of readings were under 3W, one unit registered greater than 10W (actual reading 10.5W). Further monitoring of AV receivers with DVD players in subsequent years will reveal if there are any trends emerging in standby consumption.

Figure 30 – Power measurements for AV receivers with DVD players: passive standby mode



Home Theatre Systems – Subwoofers

Subwoofers are large speakers that produce low-frequency (bass) sounds. There are two types of subwoofers: passive subwoofers rely entirely on the main amplifier for power while active subwoofers have their own power source with a separate amplifier. The 2003 survey measures active subwoofers and this is the first year that they have been measured. A home theatre system will generally have five speakers and a subwoofer, although not all home theatre systems necessarily include subwoofers in the “package”.

Only 3 subwoofers could be measured in the survey. They were measured in active standby and off. Table 49 summarises the results. Although the sample size is inadequate for drawing any conclusions, the units measured indicate that active standby is a potential problem for this product group. The minimum reading registered was 12.3W and the maximum was 14.7W. A larger sample size in forthcoming years will reveal if these readings are indicative of the product group or if they are inconsistent with other units on the market.

**Table 49 – A summary of subwoofer results
- 2003**

Appliance:		Home Theatre - Subwoofer		
Mode	No. of Measurements	Average Power (W)	Power Max	Power Min
Active	3	13.6	14.7	12.3
Off	3	0.0	0.0	0.0
Total No. of Units	3			



Price and Standby Power Consumption

For the first time, the 2003 survey noted the sale price of appliances measured in the survey. The purpose of collecting this information was to determine if any relationship exists between the performance of an appliance in standby and the purchase price. This section presents the results of that analysis. It is important to note that this analysis is only indicative due to:

- The variation in sale price of an appliance among retail outlets;
- The limited number of stores visited to conduct the survey;
- The small sample sizes of some product groupings (where there were less than 20 measurements taken for a particular appliance, these appliance types are not included in the analysis. Such small samples would provide a very poor indication of the true relationship between price and standby performance of a product);

- Other factors playing an important part in the amount of power an appliance consumes in standby, such as display panels, size of unit, etc.

Where an appliance type showed very little variation in the readings obtained in either off, passive standby or active standby (i.e. the difference between the minimum and maximum readings is less than 2W) these appliances were not included in this analysis.

Table 50 shows the appliances that were covered in the analysis, as well as a summary of the results. Generally the results indicate that, with the exception of DVD players, when there is a relationship between price and the standby consumption of an appliance, usually a higher priced appliance will consume more power in standby. On the whole however, price is not normally an indicator of a better or worse performing appliance in standby mode.

Detailed results for each of the above appliances are presented below. This is important as it tends to suggest that there is no inherent cost or technology barrier to reducing standby power consumption.

Table 50 – A summary of price vs standby power consumption analysis

Product	Mode	Conclusion
Standard Televisions (Screen size <52cm)	Passive Standby	No relationship found
Standard Televisions (Screen size >51cm)	Passive Standby	No relationship found
VCRs	Passive Standby	No relationship found
	Active Standby	More expensive models have greater standby
DVD Players	Passive Standby	More expensive models have lower standby
	Active Standby	No relationship found
Home Theatre Systems – AV receivers	Passive Standby	No relationship found
Integrated Stereos	Passive Standby	No relationship found
	Active Standby	More expensive models have greater standby
Portable Stereos	Passive Standby	No relationship found
	Active Standby	More expensive models have greater standby
Microwaves	Passive Standby	More expensive models have greater standby
Washing Machines	Off	No relationship found
	Active Standby	No relationship found

Standard Televisions

Screen size is a very important factor in television energy consumption, so for the analysis standard televisions were analysed in two groups: Group 1 includes televisions with a screen size of 52cm or less (minimum was 34cm) and Group 2 which includes televisions with a screen size of more than 51cm (maximum was 82cm). The sample sizes for each group was 18 and 38 respectively.

Figure 31 shows that the price of televisions under 52cm in screen size has no effect on the energy consumption in passive standby.

Similarly to televisions with a screen size of 51cm or less, Figure 32 illustrates that price has no impact on passive standby consumption in televisions with a screen size of 52cm to 82cm.

Figure 31 – Price vs passive standby performance: Standard TVs (screen size 34cm to 51cm)

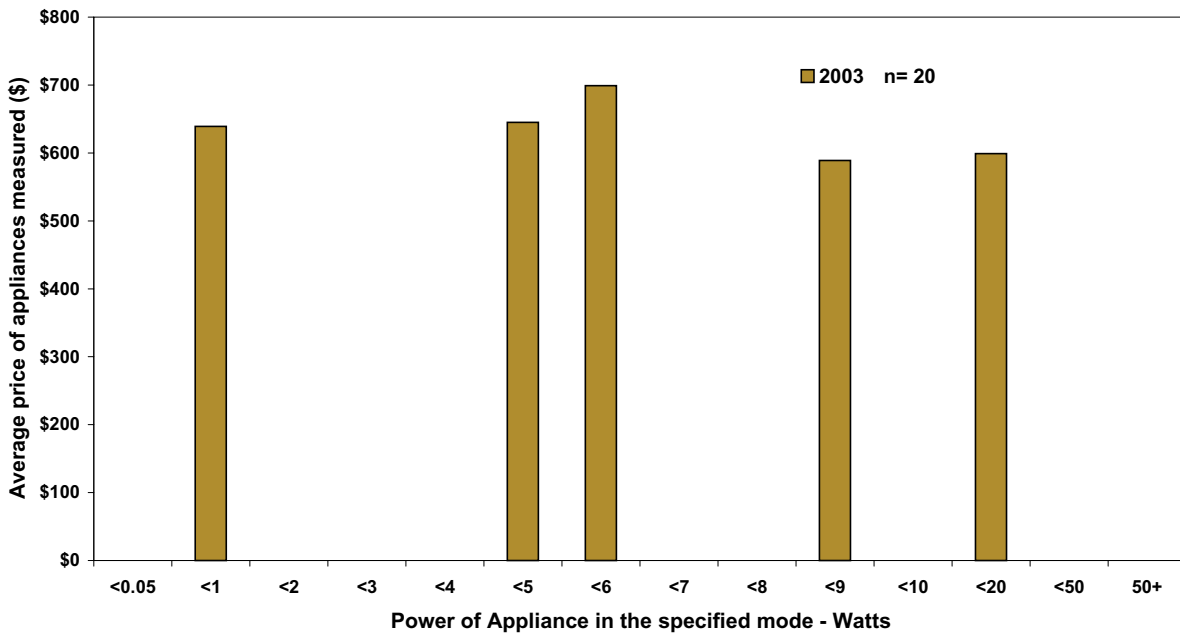
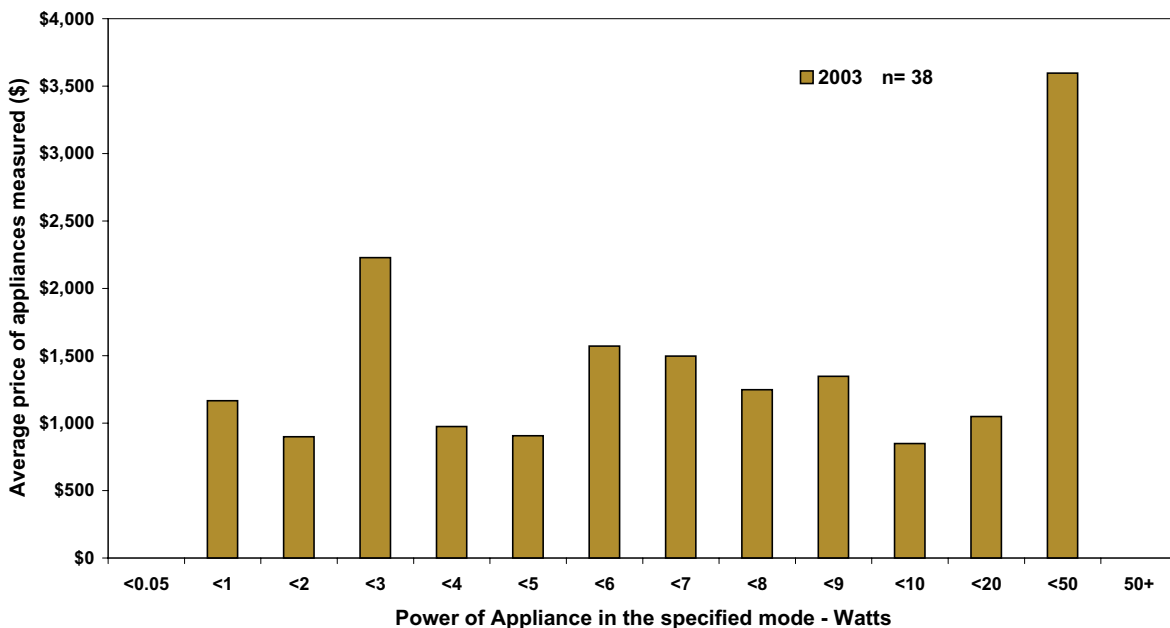


Figure 32 – Price vs passive standby performance: Standard TVs (screen size 52cm to 82cm)



VCRs

Figure 33 and Figure 34 show a comparison of price and consumption of VCRs in passive and active standby. Figure 34 illustrates that there may be a correlation between more expensive models and high active standby consumption.

Figure 33 – Price vs passive standby performance: VCRs

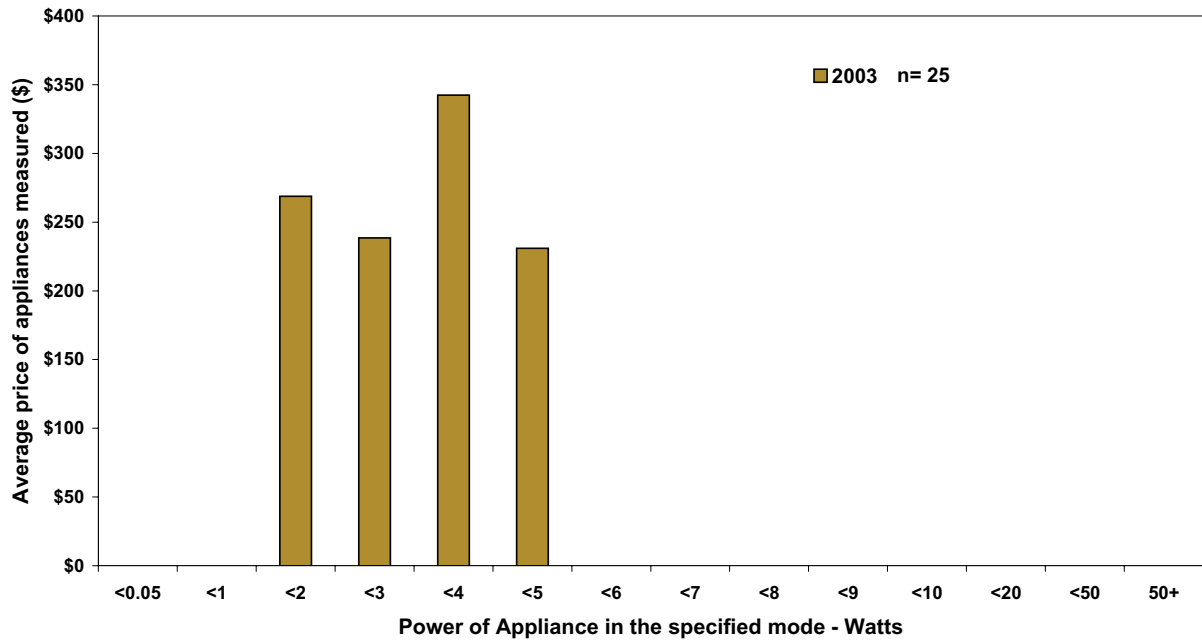
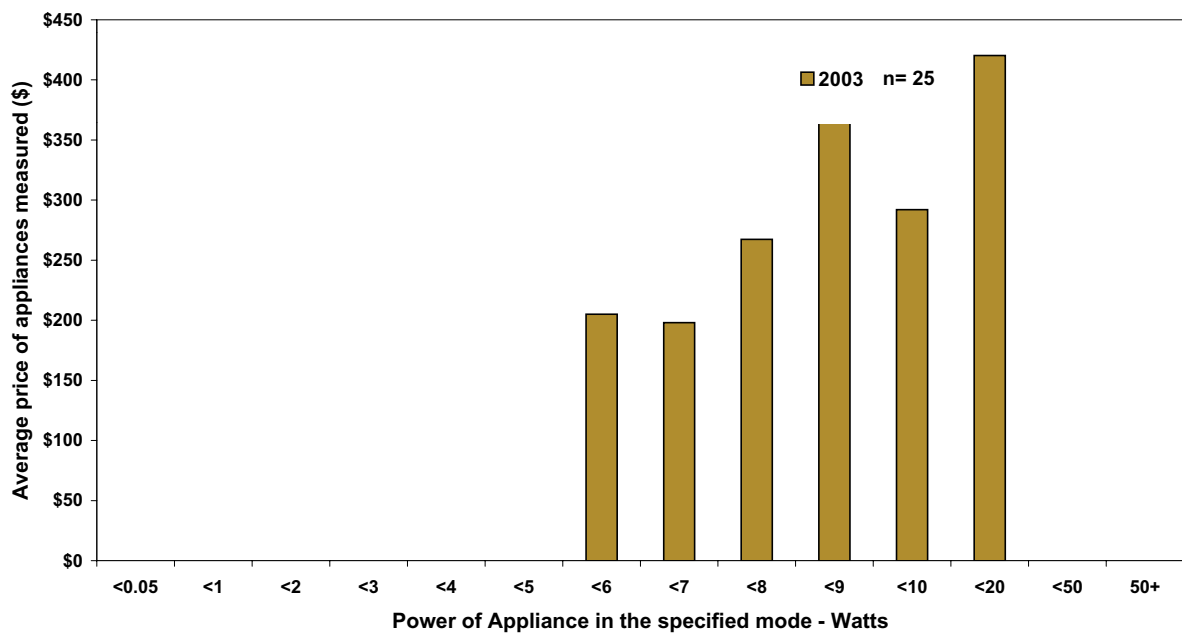


Figure 34 – Price vs active standby performance: VCRs



DVD Players

Figure 35 illustrates that more expensive DVD players registered lower passive standby readings than cheaper models. Figure 36 is inconclusive as only one model registered less than 7W in active standby.

Figure 35 – Price vs passive standby performance: DVD players

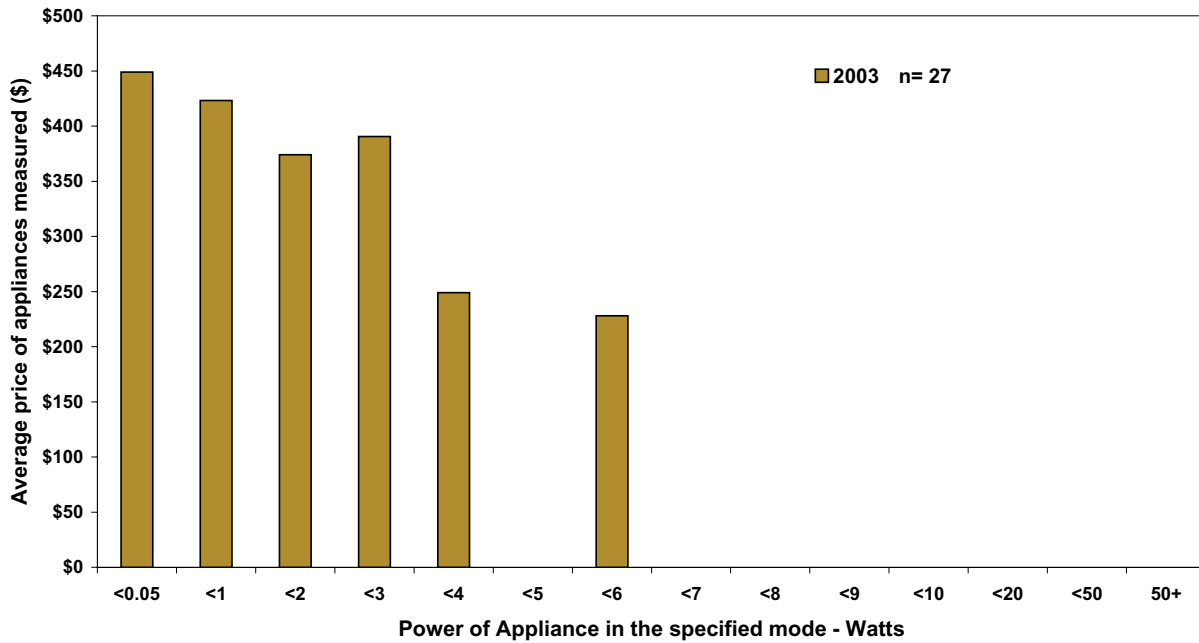
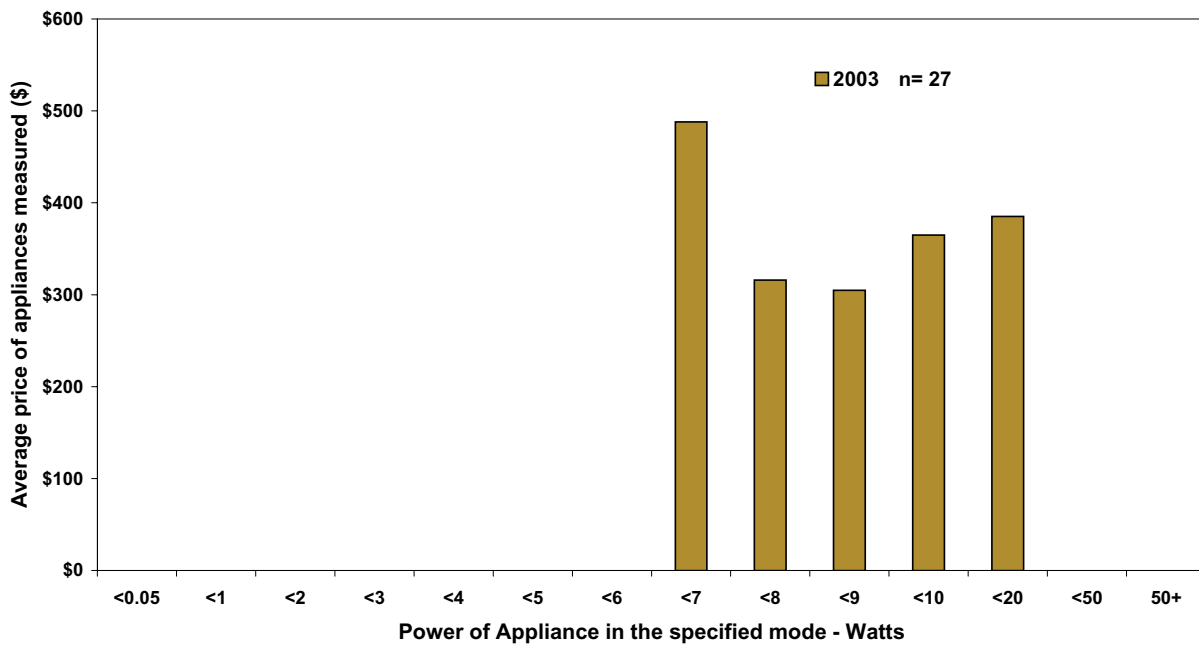
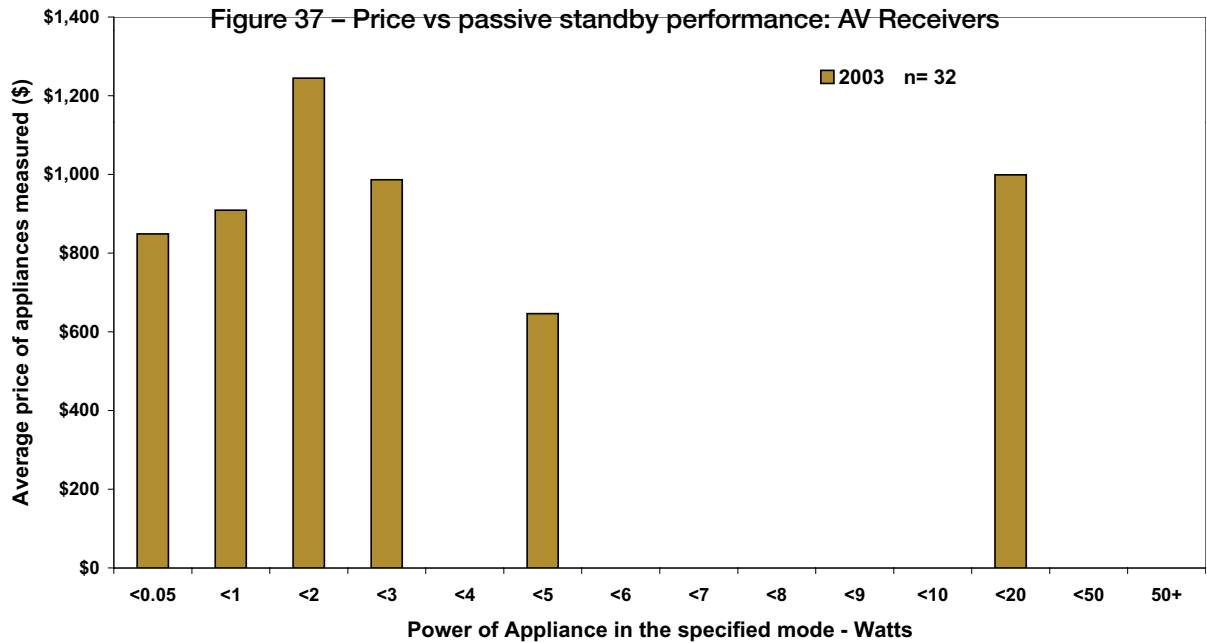


Figure 36 – Price vs active standby performance: DVD players



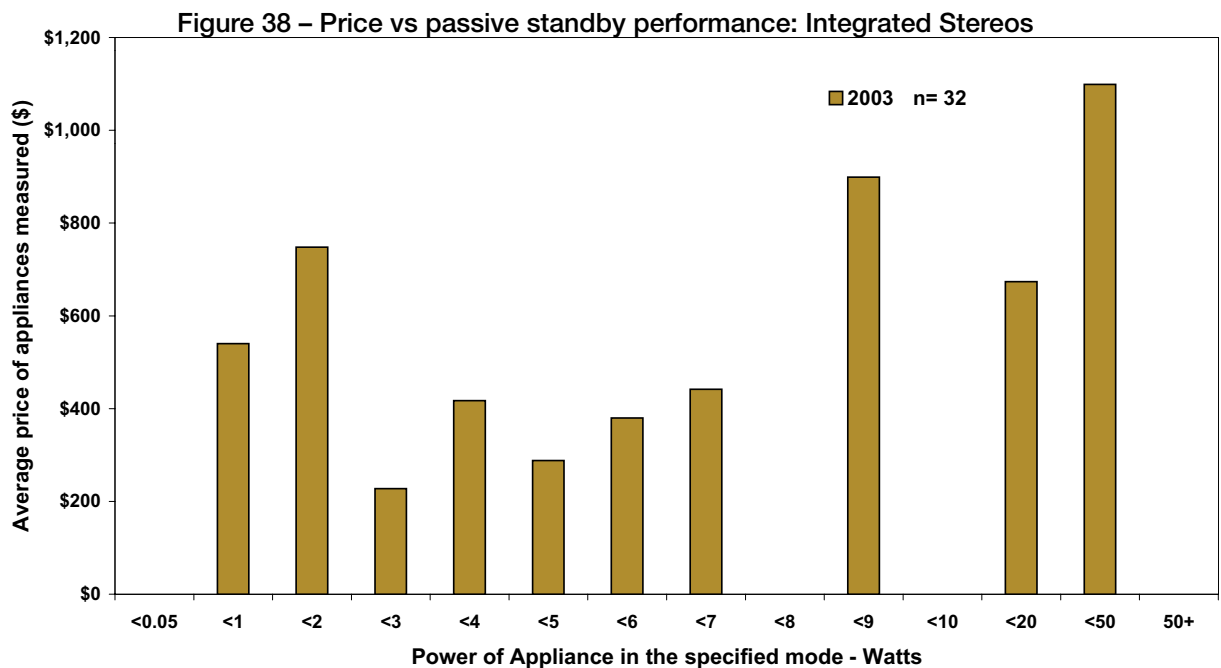
Home Theatre Systems – AV Receivers

Figure 37 illustrates that for AV receivers, passive standby varies greatly regardless of the price of the unit.



Integrated Stereos

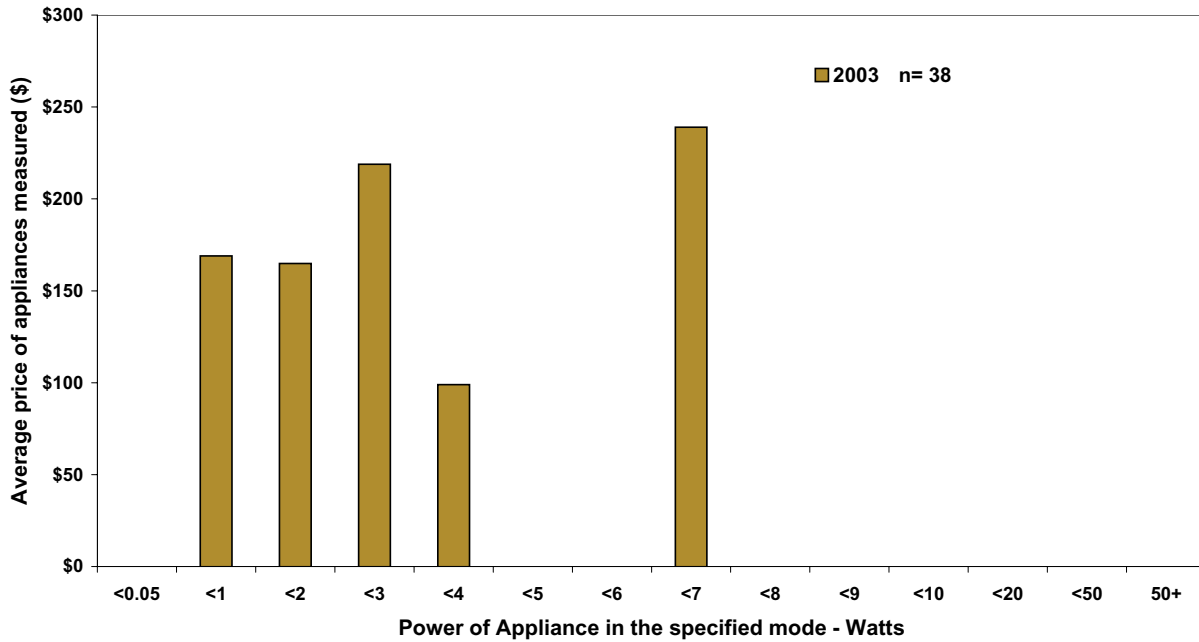
Figure 38 below shows that the integrated stereo which registered passive standby readings of more than 8W were generally more expensive than those that used less than 7W in passive standby. It is difficult to determine if there is any relationship here as there were units that used less than 3W that were very competitively priced (approximately \$230 on average).



Portable Stereos

Figure 39 illustrates that there is no clear relationship between the price of portable stereos and passive standby consumption.

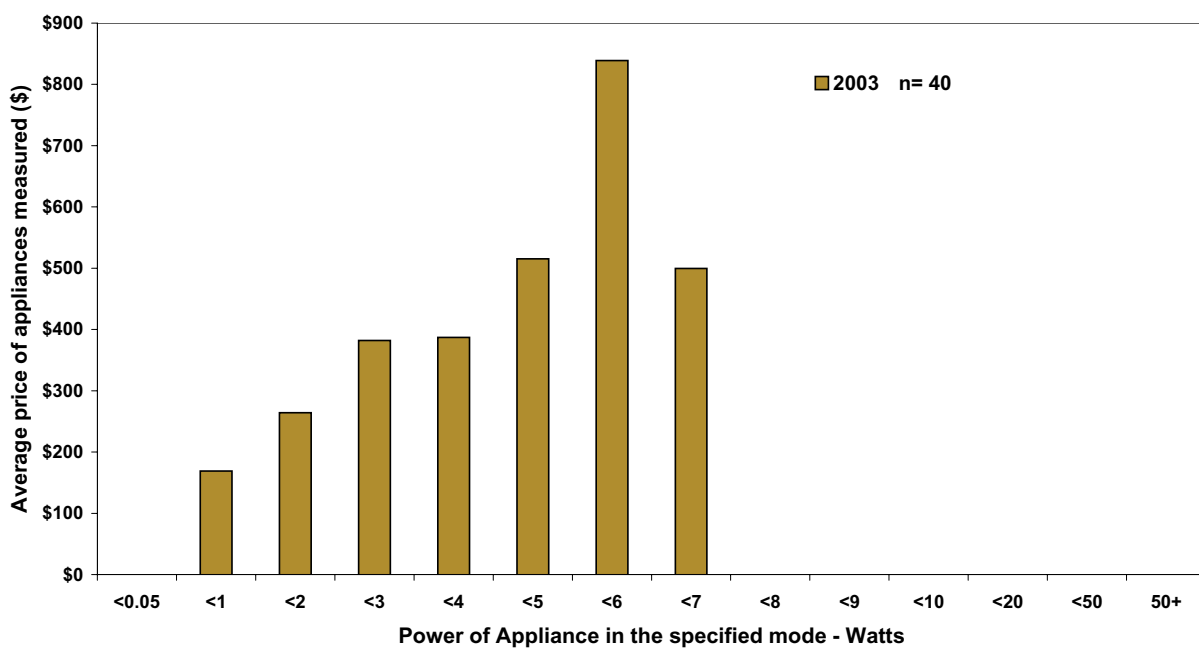
Figure 39 – Price vs passive standby performance: Portable Stereos



Microwave Ovens

Forty microwave ovens were measured in passive standby and as Figure 40 illustrates, the greater the cost of the unit, the greater the power consumption in standby.

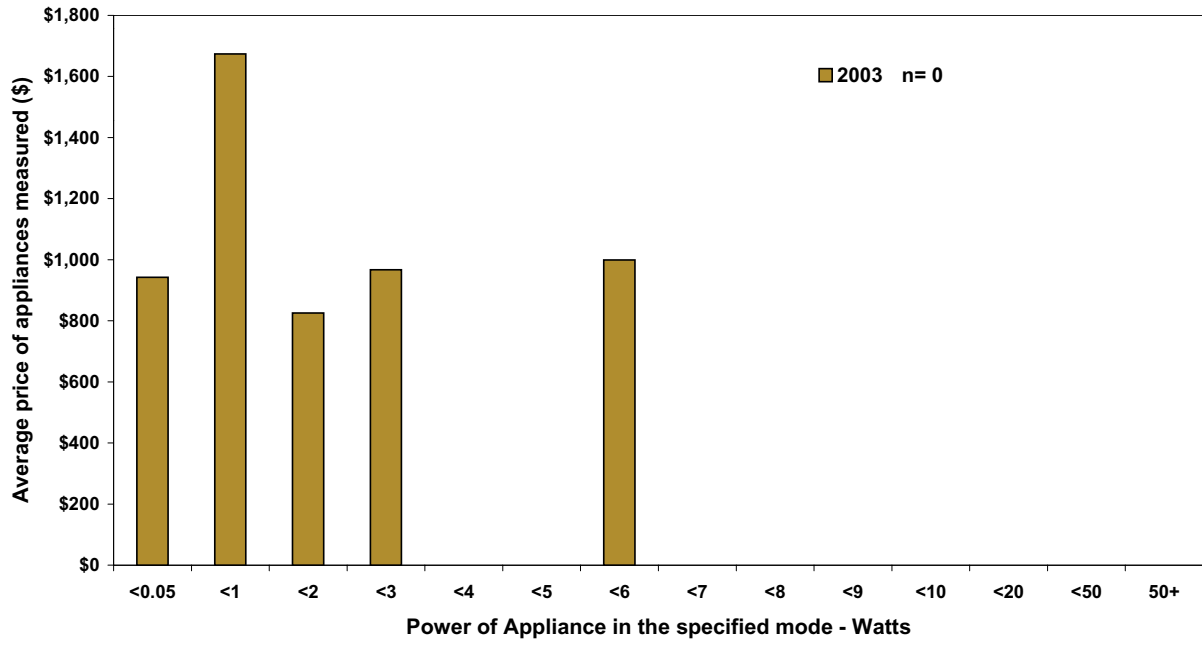
Figure 40 – Price vs passive standby performance: Microwaves



Washing Machines

Approximately half of all washing machines measured in off used less than 0.05W. Figure 41 illustrates that the average price of these machines is a little more than \$900. There does not appear to be any relationship between price and off mode consumption in washing machines.

Figure 41 – Price vs off mode measurements: Washing Machines



References

EES and EnergyConsult, 2002, *Appliance Standby Power Consumption: Store Survey 2002*, NAEEEEC report 2002/08. This report contains the detailed results of the Australian retail store standby survey undertaken in early 2002. A copy is available from www.energyrating.gov.au from the electronic library under the standby section.

EES and EnergyConsult 2001, *Quantification of Residential Standby Power Consumption In Australia: Results of Recent Survey Work*. Prepared for NAEEEEC by Lloyd Harrington of Energy Efficient Strategies and Paula Kleverlaan of EnergyConsult. This report provides results of an intrusive survey where measurements on 2,500 appliances were undertaken in 64 houses in Melbourne, Sydney and Brisbane. The report also includes results of measurements on 531 new appliances in retail outlets and results of a telephone survey of 801 households in Australia, which documents information on appliance ownership, age and usage patterns. A copy is available from www.energyrating.gov.au from the electronic library under the standby section.

An electronic copy of this report and the executive summary is available from www.energyrating.gov.au from the electronic library under the standby section.



NAEEEC MEMBER ORGANISATIONS

The Commonwealth, New Zealand, each State and each Territory are represented on NAEEEC and participate in its deliberations. Representatives are drawn from officials within Government departments, agencies and statutory authorities or from persons appointed to represent those bodies. Representatives are usually a senior officer directly responsible for energy efficiency. The membership is currently under review and may expand to include other agencies working in these fields.

The *Australian Greenhouse Office* is the lead Commonwealth agency for greenhouse matters. The Australian Greenhouse Office (AGO) is responsible for monitoring the National Greenhouse Strategy in a cooperative effort with States and Territories and with the input of local Government, industry and the community. An AGO officer is the chair of NAEEEC and others provide support for its activities.

The *NSW Ministry of Energy and Utilities* provides policy advice to the NSW Government and operates a regulatory framework aimed at facilitating environmentally responsible appliance and equipment energy use. The Ministry is represented on the Energy Efficiency and Greenhouse Gas working group through which the appliance and equipment related elements of the National Greenhouse Strategy will be progressed.

The *NSW Sustainable Energy Development Authority* was established in February 1996 with a mission to reduce the level of greenhouse emissions in New South Wales by investing in the commercialisation and use of sustainable energy technologies.

The *Office of the Chief Electrical Inspector* is the Victorian technical regulator responsible for electrical safety and equipment efficiency. Its mission is to ensure the safety of electricity supply and use throughout the State. The corporate vision of the Office is to demonstrate national leadership in electrical safety matters and to improve the superior electrical safety record in Victoria. The Office's strategic focus is to ensure a high level of compliance is sustained by industry with equipment efficiency labelling and associated regulations.

The *Sustainable Energy Authority* was established in 2000 by the Victorian Government to provide a focus for sustainable energy in Victoria. The Authority's objective is to accelerate progress towards a sustainable energy future by bringing together the best available knowledge and expertise to stimulate innovation and provide Victorians with greater choice in how they can take action to significantly improve energy sustainability.

The *Electrical Safety Office, Department of Industrial Relations*, is the Queensland technical regulator responsible for electrical safety and appliance and equipment energy efficiency. The office ensures compliance with electrical safety and efficiency regulations throughout Queensland.

The *Environmental Protection Agency*, a Division of Sustainable Industries, is Queensland's lead agency in the promotion of energy efficiency, renewable power, and other initiatives that reduce greenhouse gas emissions throughout the State. The key aim of the unit is to achieve increased investment in sustainable energy systems, technology and practice.

Energy Safety WA seeks to promote conditions that enable the energy needs of the Western Australian Community to be met safely, efficiently and economically.

The *Western Australian Sustainable Energy Development Office* promotes more efficient energy use and increased use of renewable energy to reduce greenhouse gas emissions while increasing jobs in related industries.

The *Office of the Technical Regulator* seeks to ensure the coordinated development and implementation of policies and regulatory responsibilities for the safe, efficient and responsible provision and use of energy for the benefit of the South Australian community.

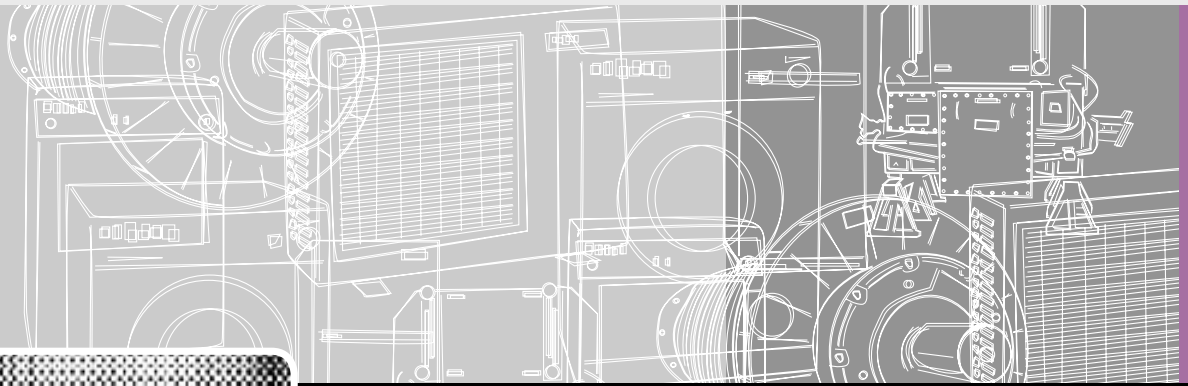
The Tasmanian Government's interest is managed by the *Office of Energy, Planning and Conservation*.

The Australian Capital Territory's interest is managed by the *Energy Policy Unit, Economic Management Branch, ACT Department of Treasury*. (<http://www.treasury.act.gov.au/energypolicy>)

The *Department of Employment, Education and Training* is responsible for the administration of regulations in the Northern Territory regarding various aspects of safety, performance and licensing for goods and services including electrical appliances.

The *Energy Efficiency and Conservation Authority (EECA)* is the principal body responsible for helping to deliver the New Zealand Government's extensive sustainable energy future. EECA's function is to encourage, promote and support energy efficiency, energy conservation and the use of renewable energy sources.

The *Ministry for the Environment (MfE)* is the lead environmental policy agency in New Zealand and is the government policy agency which advises the Minister of Energy on energy efficiency and renewables policy. MfE administers the Energy Efficiency and Conservation Act 2000, and energy efficiency regulations made under the Act.



For more information contact:

Equipment, Appliances and Transport Team
Built Environment and Communities Branch
Australian Greenhouse Office
GPO Box 621
CANBERRA ACT 2601

Facsimile: (02) 6274 1884
Email: energy.efficiency@greenhouse.gov.au

or any member organisation working
on the National Appliance and Equipment
Energy Efficiency Program.